

**PowerBox Systems®**

World Leaders in RC  
Power Supply Systems

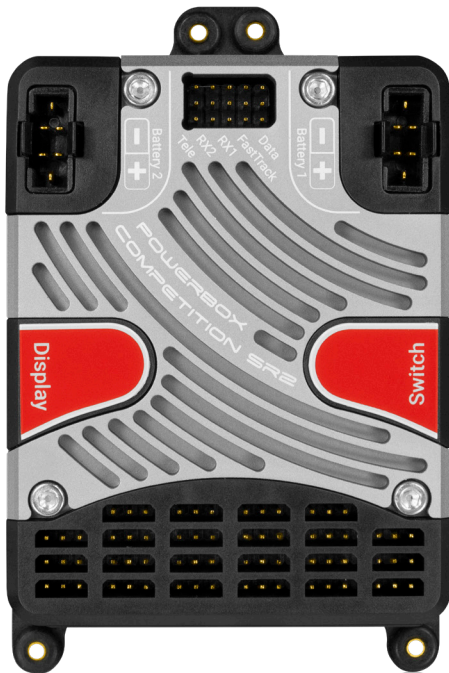

**POWERBOX  
COMPETITION SR2**

## Dear PowerBox customer,

It is now ten years ago to the month that the first **Competition SRS** was introduced. At that time it represented a milestone in the redundant deployment of receivers using our new type of bus technology. The unrestricted output assignment, servo matching and linking to early telemetry systems were unique features, and remained so for a long time.

Technology has continued to develop, and modellers' requirements have become more exacting. Here at **PowerBox Systems** we are proud to present our latest development: the **PowerBox Competition SR2**. Incorporating a new external look and the very latest technology, this single unit integrates more than twenty years of experience in the design and construction of airborne electronics.

The external changes are immediately evident: the most obvious and eye-catching feature is the new full-colour **TFT screen**, which is clearly legible even in full sunshine. The size of the screen has allowed us to include a self-explanatory menu structure which is so simple to use that its operation has raised not a single query from our test-pilots. Another obvious change is the large heat-sink, machined from solid metal, which significantly enhances the performance of the power supply. At the same time we were able to reduce the overall size of the **Competition SR2** substantially. The associated **Sensor-Switch** and **TFT screen** are also housed in a machined aluminium case, matching the quality appearance of the SR2 itself.

However, the most significant innovations only become evident once the unit is switched on. The main display contains all the essential data - including battery voltage, current, consumed capacity and all receiver-relevant information - which can be viewed at a glance. The screen also displays status messages concerning the **iGyroSAT** or **GPS III**, if connected to the system.

The menu system is clearly and logically laid out, and includes many new functions as well as the familiar menu points - and all in two languages: German and English! Important new features implemented in the new **Competition SR2** include the most efficient and sophisticated iGyro technology ever developed by **PowerBox Systems**. Used in conjunction with the optional iGyroSAT sensor, the system offers twelve gyro axes which cater for every existing model variant. The highly refined Setup Assistant enables the pilot to set up complex models, such as types with dual thrust vectors, ailerons and tailerons, in just a few minutes. Once the Assistant has been completed, the transmitter channels are assigned, the directions of gyro effect are set, and the servos connected to the outputs.

Each gyro axis can also be finely adjusted individually from the transmitter using separate channels. If an initial test-flight shows up a need to fine-tune the iGyro to meet individual requirements, a whole series of Expert settings cover every possible need.

The servo matching feature is now displayed in graphic form on the screen, and the **PowerBox Competition SR2** also allows the servo response to be adjusted using five curve points. A new development is automatic servo matching. It is a very simple matter to assign and select one or two servos in addition to the primary one, and these two or three servos can be matched accurately to each other in just a few seconds with a single button-press!

The **Competition SR2** incorporates two independent door sequencers. The standard function is designed for a retractable undercarriage, while the second can be used to implement systems such as a latching canopy control system without any additional devices. The Setup Assistant is capable of setting up the first door sequencer in just a few minutes, and three modes of operation are available. The graphic on-screen display makes additional non-standard settings very easy to set up; the entire sequential process can be observed at a glance.

If you use a PowerBox or Jeti RC system, virtually all\* the functions of the **Competition SR2** can be controlled and adjusted from the transmitter. The SR2 caters for every aspect of telemetry for battery and receiver data with all supported systems. If a **GPS III** is connected, then GPS data are also available - limited only by the facilities of the RC system in use.

\*except the sequencers and Setup Assistant

## FEATURES

- + 22 channels
- + High-performance battery backer with high continuous load capacity
- + 2.4" TFT-screen, legible in sunlight
- + Bi-lingual menu system
- + Consistent duplication of all power electronics
- + Redundant electronic switch
- + Servo matching for all 22 outputs
- + Auto matching function
- + Two independent door sequencers with Setup Assistant
- + The latest integrated iGyro technology, using the iGyroSAT as gyro sensor
- + Twelve independent gyro outputs for: 4x aileron, 4x elevator, 4x rudder
- + Individual gain control for all twelve gyro outputs
- + Special regulatory algorithm for fixed-wing models
- + System detects all transmitter mixers
- + Four selectable output voltages: 6.0 V, 7.4 V, 7.8 V or unregulated
- + Graphic menu diagrams ensure ultra-simple programming
- + Fast basic setup procedure using the sophisticated Assistant
- + Optional GPS III for speed-dependent gyro compensation
- + Telemetry data for PowerBox P<sup>2</sup>BUS, Futaba S.BUS2, Jeti Ex-BUS, Spektrum SRXL2, Multiplex M-Link and Graupner HoTT
- + Transmission of battery, receiver and GPS\* data
- + Virtually all features can be controlled from PowerBox and Jeti transmitters
- + Selectable servo frame rate: 10ms, 12ms, 14ms, 16ms, 18ms
- + Servo feedback current suppression
- + Latest 32-bit micro-processor for precise, high-speed signal processing
- + High-performance machined heat-sink for optimised heat diffusion
- + Machined, anodised aluminium switch and screen case
- + Compact dimensions

\*with **GPS III** connected

## 1. INITIAL INSTALLATION: GENERAL SEQUENCE OF OPERATIONS

When installing the unit it is important to keep to the standard sequence described below, and adhere to the subsequent setup stages, as this ensures that your installation of the **Competition SR2** will be swift and problem-free. The individual points are explained in full in the remainder of these instructions:

- Mounting the PowerBox, switch and screen
- Connecting the receiver and batteries
- Settings in the General Settings menu
- Setting up all the functions at the transmitter
- Carrying out the Setup Assistant
- Carrying out the Door Sequencer Assistant<sup>1</sup>
- Assigning all remaining functions in Output Mapping
- Setting up all control surface travels, flight modes, Dual-Rate, Expo etc. at the transmitter
- Using Servo Matching to equalise servos operating in parallel
- Learning the stick end-points in the iGyro menu <sup>2</sup>
- iGyro set-up flight <sup>2</sup>
- Fine-tuning the iGyro <sup>2</sup>

<sup>1</sup> not required if wheel doors are not present

<sup>2</sup> not required without a gyro

## 2. INSTALLATION, CONNECTIONS

### a) Mounting

The **Competition SR2** should be mounted in the model on a robust sub-structure using the four screws, rubber grommets and brass eyelets supplied in the set. The installed location is not important, but if an **iGyroSAT** is to be used, the sensor must be installed perpendicular to the model's centreline. Ideally the TFT screen should be in a clearly visible location. The very bright screen lighting makes it easy to read even in full sunshine, so no special provisions have to be made here. The screen is connected to the socket marked **Display** on the side of the PowerBox.

The switch should be mounted in the fuselage side. As with previous units, a wooden doubler should be glued to the inside of the switch aperture - especially if the fuselage is made of GRP - in order to avoid subjecting the switch to powerful vibration. The set includes a template for the switch aperture. An exposed switch is often undesirable in scale models, and for such applications we offer an alternative switch in the shape of the MagSensor. However, please note that the SensorSwitch is required for the programming procedure - unless you are using a Core or Jeti RC system - and for this reason it should always be available for use. The SensorSwitch is plugged into the socket marked **Switch** on the side of the **PowerBox**.

## b) Receivers

Once you have installed the **Competition SR2**, the screen and the switch, it is time to connect the receivers. In principle all SRS PowerBox systems are totally reliable when used with a single receiver. However, in view of the low cost of a second receiver compared with the value of the model, we always recommend installing a second receiver.

Ideally the receivers should be spaced well apart inside the model, as this increases the likelihood that at least one receiver will have good reception at all times - even under difficult reception conditions. It is permissible to extend the serial bus connection between receiver and backer to any length, as the signal is digital, and therefore extremely resistant to external influences.

The **PowerBox Competition SR2** can be used with a wide range of radio control systems: PowerBox CORE P<sup>2</sup>BUS, Futaba S.BUS2, Jeti EX-BUS, Spektrum SRXL2, Multiplex M-Link and Graupner Hott. The first four systems share one common feature: servo signals and telemetry data are carried on a bus system, and this allows the receivers to be connected to the **Competition SR2** using a single patch lead each. Multiplex and Hott systems require an additional connection between the telemetry output of the PowerBox and the receiver's telemetry input.

The **Competition SR2** automatically detects the system to which it is connected. However, when the radio is first switched on it may take a few seconds before the system is unambiguously recognised. Once detected, the unit stores the system type, and it will start immediately next time it is switched on.

### ● PowerBox CORE

Connect one or two receivers to RX1 and RX2 at the **P<sup>2</sup>BUS** output. If only one receiver is to be used, it must be connected to RX1 to provide telemetry trans-

mission. If a GPS III is connected to the FastTrack input, the Competition also delivers GPS data to the transmitter.

- **Jeti EX-BUS**

One output of the receivers you intend to use must be set to **EX-BUS**. The frame rate should be set to 10ms, and the Failsafe function must be OFF. If you intend to use only one receiver, then it must be connected to RX1 to transmit telemetry data. If a **GPS III** is connected to the FastTrack input, the Competition also delivers GPS data to the transmitter. Only the REX-Type receivers are supported

- **Futaba S.BUS2**

Connect one or two receivers to RX1 and RX2 at the **S.BUS2** output. If only one receiver is to be used, it must be connected to RX1 to provide telemetry transmission. This receiver must also be defined as the telemetry receiver at the transmitter. In order to receive telemetry data you must carry out a **Load New** process in the Telemetry Sensor menu; this action completely erases the sensor list. Now select Slot 16 in the sensor list, and select PowerBox. The telemetry data now appear in Slot 16 or later. If a **GPS III** is connected to the FastTrack input, the Competition also delivers GPS data to the transmitter.

**Note:** do not attempt to register the **PowerBox** as a sensor at the transmitter; this function is not implemented.

- **Spektrum SRXL 2**

Connect one or two SPM4651T satellites to the Competition SR2 using the optional adapter lead set (#9192). If only one receiver is to be used, it must be connected to RX1 to provide telemetry transmission. At the transmitter you will now see the battery data displayed under PowerBox Sensor. If a **GPS III** is connected to the FastTrack input, the Competition also delivers GPS data to the transmitter.

By default the Competition works in DX18 compatibility mode.

- **Multiplex M-Link**

Set the B/D sockets of the receivers you intend to use to SRXL V2. This gives you sixteen channels. The Failsafe function must be OFF.

To use telemetry you must disable the Telemetry function of one receiver using Multiplex Launcher. The **Tele** output of the PowerBox should be connected to the Sensor input of the other receiver.

If a **GPS III** is connected to the FastTrack input, the Competition also delivers GPS data to the transmitter.

- **Graupner Hott**

Set one output of both receivers to SUMD-OF16. For example, if the receiver is a GR16/24, this will be output 8. Connect these outputs to the RX1 and RX2 inputs of the PowerBox. If a **GPS III** is connected to the FastTrack input, the Competition also delivers GPS data to the transmitter.

For the telemetry function you must connect the TELE output of the PowerBox to the Telemetry input of one receiver.

**Note:** only one receiver (Bind A or Bind B) can transmit telemetry!

### c) Connecting the batteries

It is possible to use 2S LiPo, 2S Lilon, 2S LiFePo or 5S NiMH batteries with the Competition SR2. We recommend that you use our PowerPaks, which feature integral charge electronics. The fundamental rule regarding battery size is that one battery on its own should be capable of powering the model reliably.

If you intend to assemble your own batteries please note that correct polarity is vitally important. The unit does not include reverse polarity protection, as this would involve performance losses.

**Note:** connecting a battery to the **PowerBox** with incorrect polarity, even very briefly, will immediately destroy the voltage regulators!

## 3. SWITCHING ON AND OFF

This is the procedure for switching the **PowerBox** on: hold the SET button pressed in until the LED glows red. Continue to hold it pressed in while you also press buttons I and II briefly to confirm the switching process. This method enables you to switch the batteries on individually; for example, in order to check that both packs are working properly, and deliver sufficient current when all the control surfaces are moved.

The same procedure is used to switch off.



The TFT screen now displays the following image:

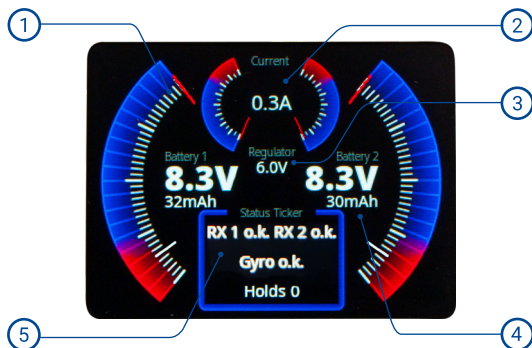

- 1 Analogue battery voltage display, with recorded minimum value. The momentary value is indicated by the red line, while the grey line indicates the minimum voltage which occurred during the flight. The scale of the analogue display is automatically adjusted to suit the battery type you have selected. The supplementary digital display indicates the exact value.
- 2 The two analogue markers show the current being drawn from the right and left battery. The digital current figure shows the sum of the currents at both inputs.
- 3 Shows the voltage present at the output.
- 4 The consumed capacity is displayed separately for both batteries. It can also be reset from the transmitter if you assign a channel to this function.
- 5 All status messages are displayed at this point: receiver status and lost frames; gyro and GPS status if connected.

## 4. MAIN MENU

To access the menu you need to hold the SET button pressed in for about 2 - 3 seconds, after which you can select the desired menu using buttons I and II. Within the individual menus the selected menu point is always displayed in red.

Press the SET button once you have selected a menu point. You can now alter the values and settings using buttons I and II.

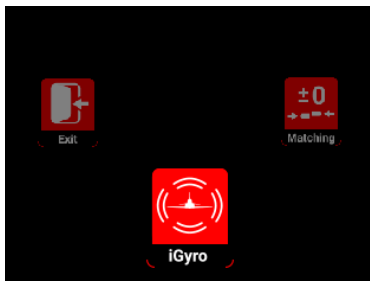

The "Rotary Menu" shown above contains the following sub-menus:

- **iGyro**

Here you will find all the settings relating to the iGyro. These features are only available if an iGyroSAT is connected to the unit.

- **Matching**

If you have servos which are mechanically inter-connected, you can use this sub-menu to adjust them to match each other using a five-point curve. You will also find the Auto Matching function here.

- **Sequencer**

At this point you can set up the two independent door sequencers, either manually or with the help of the Assistant.

- **Output**

In this menu you can assign all 22 outputs directly to any transmitter channel, to a Gyro output or to one of the two sequencers.

- **Input**

The transmitter channels are assigned to the iGyro or sequencer here.

- **General**

This menu is used to alter fundamental settings such as the language or frame rate.

- **Assistant**

**Always** use the Setup Assistant when you are preparing a new model for its first flight. This is where the transmitter input channels are determined, the model type selected, and the servos assigned to the outputs. In just a few minutes the primary functions can be ready for use, and the Assistant procedure makes it much easier to set up the gyro functions at a later stage.

## 5. GENERAL SETTINGS



Before you start using the primary functions (with the help of the Setup Assistant) and connect the servos, you should enter the basic settings in the **General Settings** menu.

Radio System	P <sup>2</sup> -BUS
Regulator Output	6.0V
Framerate	16ms
Channel Cap. Reset	16
Language	English
Reset Options	Exit

- **Radio control system**

This menu point cannot be selected manually. As already mentioned, the unit automatically detects the radio control system. If you have already connected your receivers and bound them to the transmitter, you will see at this point the radio control system it has detected.

- **Regulator output**

Here you can select your preferred output voltage: you can choose between 6.0V, 7.4V, 7.8V and unregulated output.

We recommend the 7.8V option even for HV servos, as this setting ensures that your servos operate with constant torque and transit speed for a long period after switching on. The higher voltage of the batteries, which is only present for a brief period after charging, is reduced to a level which the battery can maintain for longer.

- **Frame rate**

The default setting for this is 16ms, at which all current servo types operate reliably. Digital servos can deliver better performance if you set the frame rate to 12ms. Older analogue servos, on the other hand, may become hot if the frame rate is set too low, and will not be able to find their commanded position accurately.

- **Capacity reset channel**

Enter a channel at this point which you wish to use to reset the consumed battery capacity. The capacity is reset when the selected channel is moved to +100%.

- **Language**

Select German or English as menu language.

- **Reset options**

This menu point takes you to a sub-menu in which you can reset various settings individually or jointly.

## 6. SETUP ASSISTENT



The Setup Assistant is designed to help you complete basic channel and servo assignments quickly and easily. We recommend that you continue to use the Setup Assistant even if you are very familiar with the workings of PowerBox products. You should also use the Assistant even if you (temporarily) do not wish to use an iGyroSAT.

On the one hand the Assistant simplifies operations, because the menu initially refers to outputs in general terms, such as **DIRECT-xy**, but once you have completed the Assistant it uses specific designations, for example, **Right aileron** ... etc.

On the other hand it is possible to retro-fit an iGyroSAT without having to re-program the battery backer.

All assignments are already complete, and even the servo matching is maintained.

**Note:** When setting up the **PowerBox Competition SR2** for the first time, please keep to this sequence:

**Setup Assistant** (basic setup) → **Sequencer Assistant** → manual output assignment of all other functions.

**Before you select** the Setup Assistant, establish all the primary functions at the transmitter, ideally with 50% travel. Mixers such as delta, tailerons and thrust vector must also be programmed at the transmitter before you start. Check the functions using your transmitter's servo monitor. At this stage servo centre positions and directions of rotation do not matter.

If you also intend to use an **iGyroSAT**, you should now install the gyro sensor in a suitable position, perpendicular to the fuselage centreline, and connect it to the socket marked **FastTrack** on the Competition SR2. If you are also using a **GPS III** as telemetry sensor (and for gyro speed compensation), this should also be connected to the **FastTrack** input using a Y-lead.

Select the Assistant widget in the Main Menu, and you will see the following displays:

Setup Assistant	
Wing type	Normal
Tail type	Tailerons
Vector	No
Exit	Next

Setup Assistant	
Function	Servo count
Aileron right	2
Aileron left	2
Taileron right	1
Taileron left	1
Rudder right	1
Rudder left	1
	Next

In the first display you select the wing type (Normal / Delta) and the tail type (Normal, Tailerons or V-tail). You can also determine whether the model has a thrust vector system (Single or Dual).

On the next screen you enter the number of servos you wish to assign to individual control surfaces. The Assistant supports a maximum of three servos per control surface. This means: if your model is fitted with six aileron servos, enter 3 for the right aileron and 3 for the left aileron.

You will now see further screen displays which vary according to the data you have already entered. The following illustrations show the aileron channel as an example, based on the above data:

Move the <b>Aileron</b> stick quickly to detect the channels		
Function	Channel	Output
Aileron - A	--	--
Aileron - B	--	--
Aileron - C	--	--
Aileron - D	--	--
Back		Next

Move the <b>Aileron</b> stick quickly to detect the channels		
Function	Channel	Output
Aileron right	2	A B
Aileron left	6	T U
Taileron right	7	D
Taileron left	8	P
Back		Next

The left-hand picture shows the empty display. Now move the aileron stick at the transmitter: the PowerBox checks the input: in this example four channels should move.

The right-hand picture shows which channels have been detected, and the outputs to which you should connect the servos. Bearing in mind that your individual transmitter's channel sequence may not be as shown above, you may need to move the transmitter stick briefly and repeatedly until the detected channels appear after the appropriate functions.

**Note:** If multiple servos are mechanically coupled to a single control surface, disconnect the linkage to servos 2 and / or 3, as the servos are not yet matched to each other, and you could stall them!

Repeat the procedure with the elevator and rudder functions. After this you will be asked to enter the Gain channel for the iGyro.

Move the gain rotary for the main functions		
Function	Channel	Output
Gain main funct.	12	
Back		Next

You need to assign a channel with +/-100% travel to a rotary control at the transmitter. Even if you have not connected an iGyroSAT, this action is recommended as it will make it easier to retro-fit the gyro.

If you have selected a thrust vector function, you will see a second query regarding the sensitivity of the thrust vector control system. This is the method the Assistant uses to set up the basis for a simple but effective method of adjusting gyro gain in flight.

Once you have assigned the Gain control, press **Continue** to confirm your choice. If no iGyroSAT is connected, this concludes the Setup Assistant.

If an iGyroSAT is connected, the next step is to establish the installed orientation of the iGyroSAT:

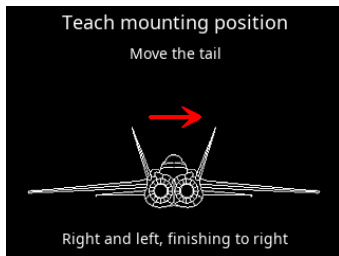
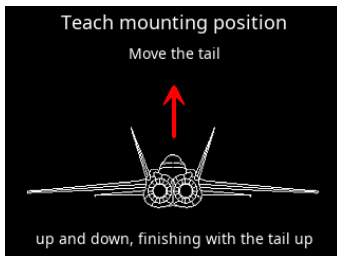

This is accomplished by moving the model in the directions shown in the graphic display: first move the tail of the model up and down two or three times. You will see that the elevators follow this movement every time - the direction of effect is not important at this stage.

At the end of the movement hold the model's tail **up** and wait until the elevators return to neutral (centre).

Now repeat the procedure with the rudder (yaw) axis: move the tail to left and right two or three times – then hold the tail to the **right** until the rudder returns to neutral.

**Note:** This procedure can be awkward to carry out with larger models. However, there is a simple trick which makes learning the installed position easier: don't fix the iGyroSAT in the model until after the learning process is complete. During the learning procedure you simply move the **iGyroSAT** in the appropriate direction, rather than the model itself!

The Assistant now continues to the process of establishing the directions of effect ("sense") and learning the transmitter control end-points. Before you carry out this procedure, it is essential to set the direction of effect and the end-points of the primary functions at the transmitter.

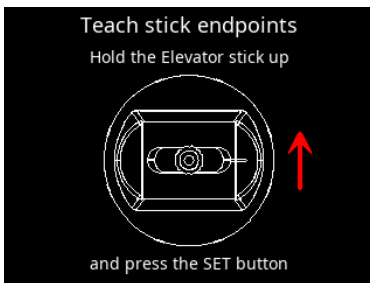

**Note:** At any time you can repeat the procedure in the Gyro menu for setting the direction of effect and the end-points. This is absolutely essential in any case if you adjust the travels or directions of effect of the primary functions while you are setting up the model.



In this menu the system learns the aileron, elevator and rudder sticks as you hold each stick in the direction shown on the screen, and press the SET button.

The Setup Assistant is now finished, but you can still assign additional outputs manually, carry out the Door Sequencer Assistant, or match multiple servos.

**Note:** In contrast to earlier versions of the PowerBox Assistant, it is now possible to repeat the Setup Assistant at any time. The system retains previously entered settings, and only overwrites the entries you have changed.

## 7.SERVO MATCHING



The Servo Matching function can be used to adjust all 22 outputs in travel and direction using five points. Its purpose is to match the travels of multiple servos which are mechanically interconnected, or which control multiple functions using only a single channel. For example, the rudder may be coupled to a steerable nosewheel.

The servo matching procedure is divided up over two screen displays: in the first you set and initialise the channel which is to be adjusted.

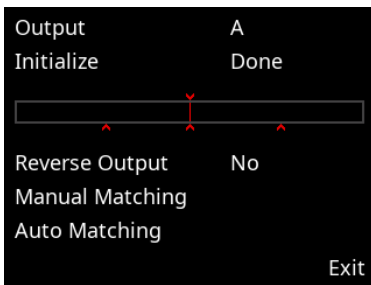

### • Initialising

First centre your transmitter stick, then select **Initialise**: now move the stick to both end-points. The screen displays the movement as a bar, and when the movement is complete, the small red markers remain in place at the end-points.

- **Reversing the output**

If you simply wish to reverse the output without adjusting any individual point, just use the SET button to select **Reverse output**.

- **Manual Matching**

Select this menu point if you want to adjust the travel of the selected servo manually using five points. The Competition SR2 switches to this display:

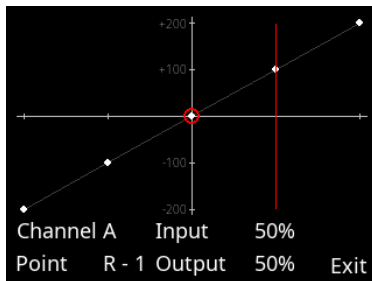

The procedure is very simple: use buttons I and II to select the point on the curve which you wish to change, then press the SET button. The servo automatically moves slowly to the corresponding point. Now you can alter the servo curve at this point using buttons I and II.

You don't need to use the transmitter to maintain the servo position; this makes accurate settings easier.

Once you have adjusted the curve point to the desired position, press the SET button again, and the servo slowly travels back to the position corresponding to the actual stick position.

If you now move the stick, you will see at **Input** the servo position corresponding to the transmitter stick position, and at **Output** the servo position now present at this servo.

**Note:** This action causes all the servos which are assigned to this input channel to move to the selected position. If this were not so, mechanically linked servos would immediately stall each other!

When you have completed all the adjustments, use button I or II to move to **End**.

## • Auto matching

The Auto matching function is a completely new development, and this is the first PowerBox product to include it. Its purpose is to match the travels of up to three mechanically interconnected servos accurately over five points, which it accomplishes in just a few seconds.

### How does auto matching work?

The Competition SR2 is fitted with the latest generation of micro-controller which is capable of measuring the current drawn from both batteries extremely quickly and precisely. The values for measured current are used to match two or three mechanically linked servos to each other.

This is accomplished by moving each servo to five points in turn and recording the lowest current values. The process is carried out in two steps: initially coarsely, then finely. A third stage then follows, in which fine-matching is carried out, taking into account any stiffness in the control surface hinges.

In the initial stage the servos are strained hard against each other for very brief periods (5 x 100ms). We have carried out hundreds of tests with this procedure, and have found that it presents no problems to servos - even low-cost examples. In fact any linkage and servo must be capable of withstanding this procedure in any case, otherwise they would not be able to cope with flight loads.

### Which servo types are suitable for auto matching?

All types of servo are suitable - with one exception: servos which do not become "soft" when the signal is switched off. There are a few digital servos which remain fixed at their position even when no signal is present. In steps 1 and 2 of auto matching this would cause the servos to draw a high current for an extended period, i.e. for as long as the matching process lasts, and this is not acceptable. Such servos can only be matched manually!

### Start

In the first servo-matching display you select your **main servo** under **Output**. In most cases this would be - in the case of ailerons - the servo closest to the fuselage. Connect the servo, and set the centre and travel at the transmitter. **Initialise** the servo with maximum travels.

Now select **Auto Matching**. At this moment all the Competition SR2's other outputs are switched off, and you will see this message:

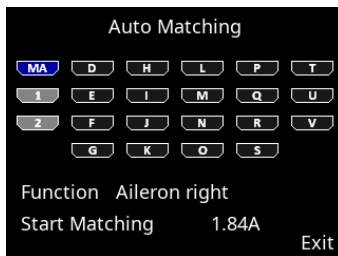
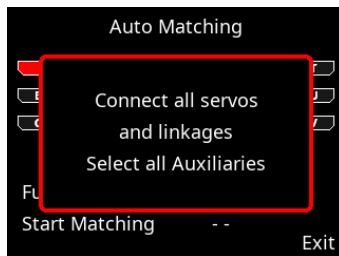

Now connect the second and - if present - the third servo to the appropriate outputs, and complete the mechanical linkages. Now use buttons I and II to move the cursor to the sockets to which the servos are connected, and press the SET button. These outputs now turn grey as **auxiliaries**. When selected, these outputs are assigned to the same input channel as the **main servo**, and initialised. This means that you do not need to set the assignment of the **auxiliaries** beforehand in **Output Mapping**, and also do not need to initialise them.

For example, if you accidentally select the wrong output, and wish to cancel your choice, the output will be reset to its previous function.

Once you have completed the selection of the participants, move the cursor to **Start Matching**: the matching process commences. If you wish to interrupt the process, you can do this by pressing the SET button.

The procedure is automatically interrupted if the system fails to detect a minimum current value; for example, if a linkage is overloaded at its end-point, or you forgot to install it.

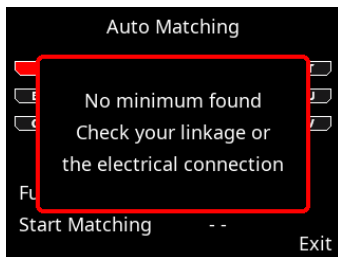
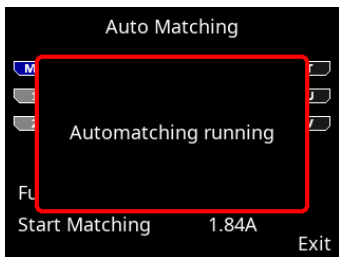

A matching process for three servos takes about 30 - 40 seconds. You can follow the current consumption directly on the screen. When the matching is finished, use the transmitter stick to run the servos to all five points. A quiet buzz from the servos in one or other position is normal. If the buzzing stops when you touch the control surface lightly with your finger, then this shows that the matching process has worked accurately.

Minor corrections can be carried out at any time under **Manual Matching**. It is a good idea to check the servo matching occasionally before and during the flying season, as servos and mechanical systems are always prone to slight drift in use.

## 8.DOORSEQUENZER

The **Competition SR2** incorporates two independent, fully programmable door sequencers. For example, **Sequencer A** can be set up to control the undercarriage and wheel doors, while **Sequencer B** could be used to implement an opening canopy with latch. The **Sequencer Assistant** is designed expressly for Sequencer A, i.e. undercarriage and wheel doors.

The Sequencer menu is divided into three parts: sequencer selection and function, the actual set-up screen for manual set-up using the graphic display, and the Setup Assistant.

Sequencer Setup	
Sequencer	Sequencer A
Function	Sequencer-A-2
Switch Channel	11
Switch Position	Up
Manual Setup	
Setup Assistant	Exit

Sequencer Setup	
Sequencer	Sequencer A
Function	Door FL
Switch Channel	11
Switch Position	Up
Manual Setup	
Setup Assistant	Exit

The two illustrations above show the method of starting the sequencer. The difference between them is this: in the left-hand picture the **Function** line shows the standard term for function 2 in sequencer A. The right-hand picture shows the specific term **Door FL** (front left) - this is the same function after the Setup Assistant has completed its work.

This means: the Assistant renames the doors in accordance with your own data, and this makes it simpler to make adjustments later. More on this below.

Regarding the individual menu points:

- **Sequencer**

Select the sequencer you want to set up: **Sequencer A** or **Sequencer B**.

- **Function**

Here you select the function which is to be adjusted. Each of the two sequencers A and B provides facilities for six individually variable functions. For example, an undercarriage with four wheel doors (individually controlled) needs five functions: four doors + retracts (valve or electronic unit).

Up to seven travel points can be set up for each function. Each travel point is defined with a servo position and a time (delay) after the start point.

- **Switched channel**

At this point you should define which transmitter channel is to be used to switch the selected sequencer. This setting is also present in **Input Mapping**. At the transmitter the switched channel travel should be set to -100% to +100%.

It is important to know that the door sequencer also includes a pause function: if you use a three-position switch and set it to 0%, the sequence stops at the current position. From this point you can continue or reverse the sequence according to the next switch position.

- **Switch position**

Here the screen shows directly the current position of the assigned channel. If this position does not coincide with your preferred transmitter switch position, you can correct it at the transmitter using servo reverse.

- **Manual Setup**

This menu enables you to set up and adjust the individual functions, and also fine-tune the timing and position of functions which the Assistant has already set up for you.

- **Setup Assistant**

As already described, the Setup Assistant prepares all the functions in the model in accordance with your requirements. The system learns all the door positions and the retract control system.

After this, the Assistant assembles these positions in accordance with your selected mode (1-2-3 - see next page) in a timed sequence. We recommend that you always use the Setup Assistant – it will save you a great deal of adjustment work, and any non-standard movements can subsequently be added at any time using **Manual Setup**.

### a) Setup Assistant

The Setup Assistant is only available for Sequencer A, and is specifically designed to cater for retractable undercarriage sequences.

Sequencer Assistant	
Mode	1
Count doors front	1
Count doors rear	2
Pause between gear and doors	6.5s
Exit	Next

Once the Setup Assistant is selected, it has to learn a number of fundamental aspects:

#### • Mode

Three modes are available, representing different sequences.

#### - Mode 1:

Extension: all wheel doors open – undercarriage extends

Retraction: undercarriage retracts – all wheel doors close

#### - Mode 2:

Extension: all wheel doors open – undercarriage extends – rear wheel doors close

Retraction: rear wheel doors open – undercarriage retracts – all wheel doors close

#### - Mode 3:

Extension: all wheel doors open – undercarriage extends – all wheel doors close

Retraction: all wheel doors open – undercarriage retracts – all wheel doors close

- **Number of wheel doors**

Enter the number of doors. If all the wheel doors are to be operated by a single valve, enter a **1** at **Number of front doors**, and leave the **Number of rear doors** vacant.

- **Pause between undercarriage and doors**

**Extend:** The time the system waits after extending the undercarriage before the wheel doors close. Applies to modes 2 and 3 only.

**Retract:** The time the system waits after retracting the undercarriage before the wheel doors close. Applies to all modes.

**Note:** All settings in the Assistant are stored – including all subsequent servo positions. For example, if you wish to change the retract mode or the pause period after completing the Assistant, simply run through the Assistant again without changing the positions. The Assistant then simply adjusts the timed sequence.

Once you have completed all these settings, select **Continue**.

Sequencer Assistant	
Connect the retracts to output C	
Position gear down	100%
Position gear up	-100%
Back	Done

Sequencer Assistant	
Connect the rear right door to output f	
Position door closed	100%
Position door opened	-100%
Back	Done

The positions of the undercarriage control system and all the wheel doors are now set up in accordance with the number of wheel doors you have entered. At this point you should connect the retract control unit and the wheel doors to the appropriate output of the Competition SR2. Starting with **A** the Assistant searches for outputs which have no special functions – i.e. **Direct xy** outputs, which are not assigned to a gyro or other sequencer function.



**Note:** it is important to keep to the standard sequence when installing the **Competition SR2** for the first time:

**Setup Assistant** (basic setup) → **Sequencer Assistant** → manual output assignment of all other functions.

If you ignore this, the Sequencer Assistant could overwrite **Direct** functions which are already assigned.

When the positions are being established you will see that the wheel doors and the undercarriage itself always follow the cursor position, and slowly approach the set position. If you wish to adjust these positions, press the SET button and make changes using buttons I and II. Select **Finished** to adjust the other wheel doors. Once all the doors are correctly adjusted, the following display appears, and you may be asked to move the retract switch to **Extended**:

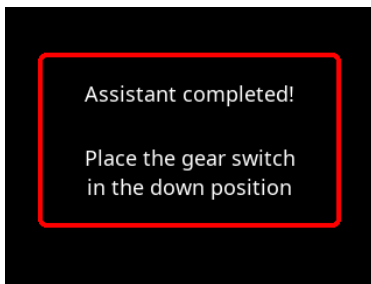

The Assistant now opens all the wheel doors and moves the undercarriage to the **Extended** position. At this point you can check the operation of the sequencer by operating the retract switch on the transmitter. If you find a problem - perhaps the pause between the undercarriage and the wheel doors is too short - you just select the Assistant again, and change the appropriate setting. There is no need to re-adjust the wheel door positions.

Should you wish to set up additional wheel doors or travel points, you can do this at any time in **Manual Setup**.

## b) Manual Setup

You will find an overall view of the sequence for the selected function in the main Sequencer menu.

The upper line shows the sequence in the forward direction (extension), the lower line the reverse sequence (retraction).

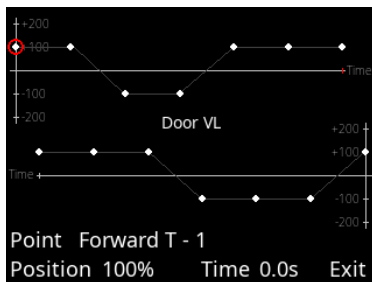

In Manual Setup you can set seven travel points in time and position for each function; forward and reverse processes are individually variable.

The current position and time are shown in the bottom line of the screen.

Use buttons I and II to select the point you wish to change. The position of the servo follows the position of the cursor on the line. For example, if you select a point which stands at +80%, the corresponding servo moves slowly to the +80% position.

**Note:** When adjusting the wheel doors you should start by retracting and disabling the undercarriage itself, otherwise there is a risk of the doors fouling the wheel legs and causing mechanical damage.

To adjust a point, select the appropriate point using buttons I or II, and press the SET button; you can now adjust its position. Once the position is correct, you can set the time after pressing the SET button again.

All seven points are permanent. If you want a particular point to produce no servo movement, set its position to the same value as that of the previous point.

This is shown in the example above, where the three right-hand points on the upper line are at the same position. As a basic rule the time can only be entered between the two points at left and right. If you want to shorten the entire sequence, you must move all the points.

It is possible to test the sequence without leaving the menu: move the cursor to **TEST** at bottom right; this action transfers control to the retract switch on the transmitter. The **TEST** select point changes to **Exit** - press the SET button here to leave the menu completely.

## 9. OUTPUT MAPPING



Output Mapping enables you to assign servo sockets to the transmitter channels and the gyro and sequencer functions.

All 22 outputs can be assigned, and there are no restrictions. For example, output A can be direct channel 5 from the transmitter, or a door sequencer function. It is also possible to assign one function to multiple outputs. For example, two elevator servos can be controlled from just one transmitter channel. Servo matching can then be used to match the control surfaces accurately to each other. This facility saves channels at the transmitter, where they can be in short supply.

Output Mapping is also used to set the Failsafe response of each individual channel.

In the **Output Mapping** display you use buttons I and II to select the output you wish to assign:

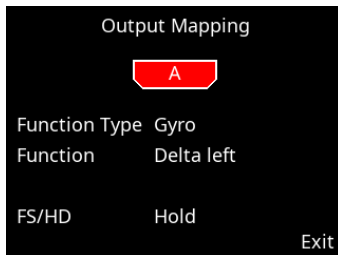
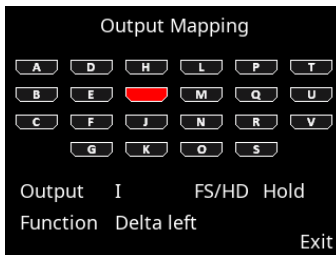

Press the SET button to select the output. On the next screen you can now define the output:

- **Function type**

Three different function types are available:

- Direkt**

Selecting a **Direct** channel assigns a transmitter channel directly to the selected output without modification (except for servo matching). For example, if you assign Direct 5 to output V, then output V responds to channel 5 at your transmitter.

- Gyro outputs**

Once the Setup Assistant is complete, you can assign the gyro channels to the outputs. At the Select stage you will find, for example, **Aileron**, **Elevator** and **Rudder** functions. These functions can also be assigned to the outputs more than once. For instance, if you are setting up a model with three aileron servos in each wing, then you will find three instances of **Right aileron** and **Left aileron**.

Gyro channels not assigned through the Setup Assistant are designated Aileron-ABCD, Elevator-ABCD and Rudder-ABCD.

- Sequencer A and Sequencer B**

This function type contains six outputs for each of the door sequencer functions. As in the case of the gyro, the sequencer outputs have general designations if the Assistant has not yet been completed - for example, Sequencer A-1. Once the Sequencer Assistant has been used, they are assigned specific names such as Door FL (front left) or Door RR (rear right).

- **Function**

At the Function point you can use buttons I and II to choose the function you wish to assign to the output. Various options are available here, depending on the function type you have selected.

- **FS/HD**

This is where you set the Failsafe response for the selected output. By default all outputs are set to Hold mode. However, it is really essential to set Failsafe (**FS**) on throttle, so that the power system is throttled back or cut completely should the signal be lost. In many countries this is a legal requirement in any case.

If you set an output to Failsafe, all current positions are adopted from the transmitter when you leave the menu point.

This means: you should move all channels to the desired position at the transmitter before you set an output to Failsafe.

The usual way to check the setting is to move the throttle channel to the half-way point, then switch the transmitter off: the throttle servo must now immediately move to the Idle position.

If you are using a **CORE** system, the Failsafe settings are adopted from the transmitter; this overwrites any Failsafe settings which you select at the **PowerBox Competition SR2**.

## 10. INPUT MAPPING



The Input Mapping menu is used to assign the channels coming from the transmitter to functions such as Gyro, Sequencer or capacity reset. The assignment process is carried out by the Setup Assistant and the Sequencer Assistant. If you add functions later, or change channels at the transmitter, it is possible to make appropriate adjustments subsequently at any time.

In particular, assigning different Gain channels for the iGyro makes it easier to enter the settings for more complex applications.

Input Mapping Gyro Aileron	
Aileron - A	2
Gain Aileron - A	9
Aileron - B	6
Gain Aileron - B	9
Aileron - C	7
Gain Aileron - C	10
Aileron - D	8
Gain Aileron - D	10

Input Mapping Gyro Aileron	
Aileron right	2
Gain Aileron - A	9
Aileron left	6
Gain Aileron - B	9
Taileron right	7
Gain Aileron - C	10
Taileron left	8
Gain Aileron - D	10

The screenshots above show once more that the Setup Assistant determines the function designations. On the left we see the general function names, whereas on the right - after carrying out the Assistant - the names are specific to your model.

These pictures also clearly show the separate Gain channels for each gyro function.

For example, aileron, elevator and rudder can be assigned three different Gain channels, which can then be adjusted individually in a single test-flight. To assign a channel, use buttons I and II to select the function, then press the SET button. You now have two options for choosing the channel:

- Use buttons I and II
- Simply move the transmitter stick: the channel is automatically detected. If more than one channel is assigned to a particular transmitter control (for example, channels 2 and 6 for aileron control), repeatedly move the stick briefly from centre until the desired channel is selected.

Press the SET button to confirm your choice.

## 11. IGYRO



The iGyro menu provides access to a whole range of Expert settings which enable you to fine-tune the iGyro to meet your specific requirements.

The iGyro menu requires an **iGyroSAT** connected to the FastTrack input of the Competition SR2 as sensor unit. An optional **GPS III** - also connected to FastTrack - can be used to provide speed compensation for gyro gain.

It is important to carry out the Setup Assistant before you make any changes to the iGyro settings, as all the channel assignments will then be correct. A single test-flight with the base values then forms a good starting point for further fine-tuning.

Gyro axis	Aileron right	Teach mounting position
Range	Range A	Teach stick endpoints
Gain	75%	
Attitude Assist	Off	
Characteristic	Hard	
Stickpriority	100%	
Lockfeel	20%	
Airspeed Factor	4	Exit

### • Gyro axis

At this point you select the gyro axis which you want to adjust. Four axes are available for each of aileron / elevator and rudder.

- **Range**

Two ranges are available, each of which can be adjusted separately for each axis: range A and range B. Range A applies to values of the gain control (or gain switch, once set up) between 0% and +100%, while range B runs from 0% to -100%. At 0% the iGyro is completely disabled.

This enables you to set up two ranges: one range with Attitude Assist and a second without Attitude Assist. You can select either range in flight by means of a switch.

- **Attitude Assist**

We selected the term Attitude Assist because the iGyro's "Heading" actually differs substantially from the Hold modes used by other gyro manufacturers. Attitude Assist can also be used on the elevator without any problem, as it is only active at the stick's centre point, and there is no risk of causing a stall. As soon as the stick is moved, Attitude Assist is disabled, and the model 'feels' perfectly normal. Once the Setup Assistant has been completed, Attitude Assist is active on aileron in range B by default.

- **Characteristic**

Changing this value hardens and softens the regulatory behaviour of the iGyro. If the model appears to respond too abruptly in gusty conditions, you should change the value in the direction of Soft. If you think that the iGyro responds too slowly to gusts of wind, change it in the direction of Ultra.

- **Stick Priority**

The default value for this menu point is 100%, which means that the gyro function is completely suppressed when the stick is moved to its end-point. If you set stick priority to 200%, for example, the gyro function will be completely suppressed when the stick is at half-travel. The result is a more agile model, but at the cost of a faster reduction in gyro effect as the stick movement is increased.

- **Locking characteristics**

This feature affects the model's ability to 'lock' in manoeuvres such as four-point rolls. If the value is set too high, the result is a tendency to overshoot or oscillate at the moment the stick is released. If the value is too low, the locking may not appear sufficiently sharp.

- **Airspeed Factor**

This value defines the effect of speed-dependent variation in gyro gain. The setting only applies if a **GPS III** is connected to **FastTrack** as well as an **iGyroSAT**.

The airspeed factor should be increased if the model displays good gyro response at low to medium speed, but tends to oscillate at high speeds. Over the years the default value of 4 has proved ideal for all kinds of model.

- **Learning the installed orientation**

In this menu the unit learns the installed orientation of the **iGyroSAT**. In most cases this has already been established in the **Setup Assistant**, but if you change the location or the orientation of the **iGyroSAT**, you will need to use this menu point again.

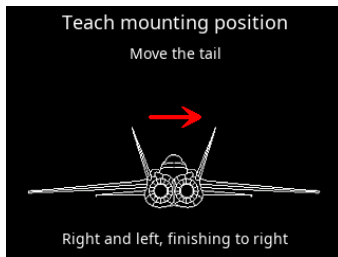
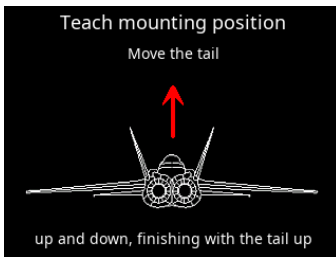

The orientation of the gyro is established by moving the model in the directions shown on the screen: to ensure that detection is absolutely reliable, move the tail of the model smoothly up and down several times before holding the tail up until the elevators return to neutral. The direction of effect is not important at this stage. The diagram of the little afterburners on the screen lets you know whether the movement was sufficient!

Repeat the procedure with movement of the rudder: move it left and right repeatedly, then hold it in the "right" position.

**Note:** With larger models this procedure can be awkward to carry out. However, there is a simple trick which makes establishing the installed position easier: don't fix the iGyroSAT in the model until after the learning process is complete. During the learning procedure you simply move the **iGyroSAT** in the appropriate direction, rather than the model itself!



### • Learning the transmitter stick end-points

This setting is very important, and should always be carried out if you alter the centre or end-points of the aileron, elevator or rudder gyro functions.

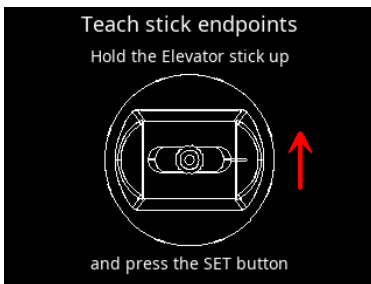

Follow the instructions on the screen to learn the stick end-points. Please note that you must select the stick you wish to learn, and hold it at its end-point while you press the SET button.

## 12. GYRO SETTINGS - BEFORE THE FIRST FLIGHT

It is absolutely essential to carry out Point 12 if you have installed an **iGyroSAT**. You must also complete the following points before you start fine-tuning the iGyro in flight:

- Settings in the General Settings menu
- Setup Assistant completed – installed orientation learned
- Door sequencer set up if appropriate
- All other functions assigned, including throttle, flaps etc.
- All functions set up correctly: servo centre, end-points, servo matching, Dual Rates and Expo

The next step is to enter the iGyro menu with the cursor right at the bottom, so that the menu jumps to the second page. There you will find the **Learn transmitter stick end-points** menu point. Carry out this step as described above, in order to calibrate all the settings which have been entered in the course of the installation procedure.

Once you have completed these steps, turn the gyro gain control (or controls, if your model has a vector control system) to maximum, and check the direction of effect of the gyro. The intelligent iGyro learning process effectively prevents the need for corrections here - unless you have made an error when learning the sticks or the installed orientation. If this should happen, simply repeat the appropriate point in the iGyro menu.

It is important to know that the gain control has two ranges, as explained above: range A and range B. In range B the Assistant assigns Attitude Assist to the aileron function. We recommend this setting on the ailerons, as it results in very precise gyro response. During the test-flight we suggest that you turn the gain control to the left (0% to -100%) in order to make use of this feature immediately. Later on you can fine-tune ranges A and B individually at any time.

Your model is now ready to fly. Set the gyro gain control to 0%, and take the model off. On this first flight it should be trimmed out carefully without using the gyro function.

Should you need to adjust the trims, or correct the control surface travels, during or after that first flight, it is essential to re-learn the stick end-points in the Gyro menu.

The iGyro is now ready for the model's initial set-up flight. Take the aircraft off with gyro gain set to 0%. Hold the model straight and level while you (or a colleague) slowly turn the gain control to the left - or right, if you do not want to use Attitude Assist on the ailerons.

Slowly turn the gain control until the model begins to oscillate. Once you have found this point, turn the gain control back slightly. Now fly a few circuits with this setting. Fly loops, rolls, knife-edge passes, and the model should exhibit no tendency to oscillate at any time.

As soon as you have found this optimum setting, bring the model in for a landing. Switch to your transmitter's servo monitor, and read off the percentage value for gain. You can now swap the rotary control for a switch, and enter the associated servo travel as the percentage you have just established. A value of 0% disables the gyro.

If your model features thrust vector control, the Setup Assistant has already assigned a second gain control. This is used to set the optimum gyro response for the vector function in a separate test-flight. Gyro gain for thrust vector control generally requires a value higher than 100%. Since the **Competition SR2** features integral gain controls for each individual gyro function, it is possible to implement different flight modes at the transmitter with no great effort.

### 13. SPECIFICATION

Operating voltage	4.0 V - 9.0 V
Power supply	2S LiPo, 2S Lilon, 2S LiFePo, 5S NiMH
Current drain, operating	260 mA
Current drain, stand-by	30 $\mu$ A
Maximum current capacity	2 x 20 A continuous (<30 s: 2 x 40 A)
Drop-out voltage	0.3 V
Output voltage	6.0V, 7.4V, 7.8V, unregulated
Signal input	Serial
RC systems supported	PowerBox, Futaba, Jeti, Spektrum, M-Link and Hott
Receiver redundancy	SRS
Channels	26
Servo outputs, total	22
Servo signal resolution	0.5 $\mu$ s
Signal repeat rate	10ms, 12ms, 14ms, 16ms, 18ms
Gyro modes	Heading mode, Normal mode
Gyro sensor type	External iGyro SAT
Number of sensor axes	12
Telemetry systems supported	P <sup>2</sup> BUS, S.BUS2, EX-Tele, SRXL2, M-Link, Hott
Dimensions	107 x 69 x 19 mm
Weight	115 g
Weight, Sensor-Switch	15 g
Temperature range	-30 °C to +75 °C

### 14. SET CONTENTS

- **PowerBox Competition SR2**
- **TFT-Display**
- **SensorSwitch**
- 2 patch-leads
- 8 retaining screws
- 4 rubber grommets and brass sleeves
- Operating instructions

## 15. DIMENSIONS

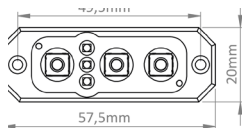
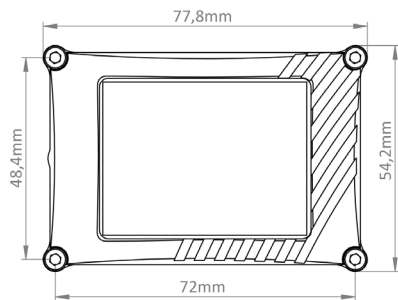
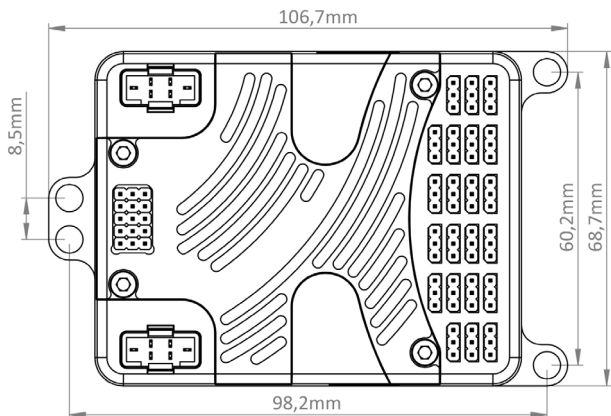

## 16. ACCESSORIES

### - PowerBox iGyro SAT

Order No.: 3610

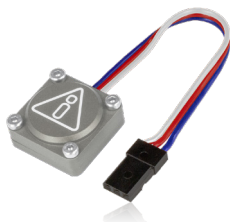

#### Features:

- + Extremely accurate triple-axis MEMS sensor
- + Special regulatory algorithm designed for fixed-wing model aircraft
- + Outputs the new FastTrack serial bus
- + Plug and Play with all PowerBox receivers
- + Installed orientation can be selected
- + 16-bit processor for fast, high-resolution signal processing
- + Robust aluminium case

### - GPS III

Order No.: 3525



#### Features:

- + Latest generation of GPS
- + Helix antenna for reception regardless of flight attitude
- + Reception even under difficult conditions
- + Fast response to speed changes
- + Automatic system detection
- + LED status indicator
- + Accurate 3D speed
- + Height measurement (altimeter)
- + Distance, optionally as 2D or 3D value
- + Distance covered

## 17. SERVICE NOTE

We make every effort to provide a good service to our customers, and have now established a **Support Forum** which covers all queries relating to our products. This helps us considerably, as we no longer have to answer frequently asked questions again and again. At the same time it gives you the opportunity to obtain assistance all round the clock, and even at weekends. The answers come from the **PowerBox team**, which guarantees that the answers are correct.

Please use the Support Forum **before** you contact us by telephone.

You will find the forum at the following address:

**[www.forum.powerbox-systems.com](http://www.forum.powerbox-systems.com)**



### SERVICE ADDRESS

**PowerBox-Systems GmbH**

Ludwig-Auer-Straße 5

86609 Donauwoerth

Germany

## 18. GUARANTEE CONDITIONS

At **PowerBox-Systems** we insist on the highest possible quality standards in the development and manufacture of our products.

They are guaranteed **"Made in Germany"**!

That is why we are able to grant a **24 month guarantee** on our **Competition SR2** from the initial date of purchase. The guarantee covers proven material faults, which will be corrected by us at no charge to you. As a precautionary measure, we are obliged to point out that we reserve the right to replace the unit if we deem the repair to be economically unviable. Repairs which our Service department carries out for you do not extend the original guarantee period.

The guarantee does not cover damage caused by incorrect usage, e.g. reverse polarity, excessive vibration, excessive voltage, damp, fuel, and short-circuits. The same applies to defects due to severe wear.

We accept no liability for transit damage or loss of your shipment. If you wish to make a claim under guarantee, please send the device to the following address, together with proof of purchase and a description of the defect:

## 19. LIABILITY EXCLUSION

We are not in a position to ensure that you observe our instructions regarding installation of the **PowerBox Competition SR2**, fulfil the recommended conditions when using the unit, or maintain the entire radio control system competently.

For this reason we deny liability for loss, damage or costs which arise due to the use or operation of the **PowerBox Competition SR2**, or which are connected with such use in any way. Regardless of the legal arguments employed, our obligation to pay damages is limited to the invoice total of our products which were involved in the event, insofar as this is deemed legally permissible.

We wish you every success using your new **PowerBox Competition SR2!**



Donauwoerth, April 2021

## **PowerBox-Systems GmbH**

Ludwig-Auer-Straße 5  
86609 Donauwörth  
Germany

 +49-906-99 99 9-200

 +49-906-99 99 9-209

**[www.powerbox-systems.com](http://www.powerbox-systems.com)**