



PowerBox Systems®

World Leaders in RC
Power Supply Systems



POWERBOX
MERCURY SR2

Dear PowerBox customer,

Congratulations on your new PowerBox power supply unit! The **PowerBox Mercury SR2** is your first choice when you need a small, high-performance power supply unit with maximum functionality. All the features which are usually the preserve of the larger power supply units are present in the compact **PowerBox Mercury SR2**: iGyro, servo matching, unrestricted channel assignment and even a door sequencer: it really is a complete system!

The **PowerBox Mercury SR2** provides 16 freely assignable outputs with servo matching, i.e. the travel of each channel can be adjusted at five points. If you fly models with large control surfaces, in which individual control surfaces are actuated by two servos, the unique auto-match function can be used to match both servos to each other accurately in a matter of seconds.

The integral iGyro software requires a sensor unit in the form of an **iGyro SAT**; with this it can address and adjust three aileron, three elevator and three rudder functions individually. The Setup Assistant simplifies the initial adjustments to the gyro system, reducing the time required to just a few minutes. The first time the system is used, the Assistant gathers basic information regarding wing and tail format and the vector control system - if present. A complex model matrix then works in the background, calculating which servo needs to be connected to which output, at the same time linking the corresponding gyro function. A wide range of additional Expert settings offers total freedom, enabling you to fine-tune the gyro system to your particular requirements.

In addition the **GPSIII** or **PBS-TAV** (True Airspeed Vario) can also be connected to the **FastTrack** input, making it possible to vary gyro gain according to airspeed. All GPS or TAV information is even available for telemetry at the transmitter!

The **PowerBox Mercury SR2** supplies a regulated output voltage which can be set to 6.0V or 7.8V. The two voltage regulators offer generous capacity thanks to the machined aluminium heatsink on the top and bottom surfaces, enabling the unit to cope effortlessly with the current-hungry servos used in 3D machines.

The integral door sequencer is capable of controlling one undercarriage system and up to three wheel doors. If the Setup Assistant is used, it takes just a few minutes to learn the end-points of door travel, while three pre-defined modes cover the vast majority of undercarriage processes. Once initially set up, the timing of the process can be fine-tuned manually to any values you wish.

For PowerBox and Jeti pilots it is possible to control and adjust virtually every* aspect of the **PowerBox Mercury SR2** from your transmitter! Full telemetry for battery and receiver data is present for all supported systems

*With the exception of the door sequencer and Setup Assistant

FEATURES

- + 16 channels
- + High-performance battery backer with high continuous load capacity
- + OLED screen M, legible in sunlight
- + Bi-lingual menu system
- + Consistent duplication of all power electronics
- + Redundant electronic switch
- + Servo matching for all 16 outputs
- + Auto matching function
- + Door sequencers with Setup Assistant
- + The latest integrated iGyro technology, using the iGyroSAT as gyro sensor
- + Nine independent gyro outputs for: 3x aileron, 3x elevator, 3x rudder
- + Individual gain control for all nine gyro outputs
- + Special regulatory algorithm for fixed-wing models
- + System detects all transmitter mixers
- + Four selectable output voltages: 6.0V or 7.8V
- + Fast basic setup procedure using the sophisticated Assistant
- + Optional GPSIII or PBS-TAV for speed-dependent gyro compensation
- + Telemetry data for PowerBox P²BUS, Futaba S.BUS2, Jeti Ex-BUS, Spektrum SRXL2, Multiplex M-Link, JR DMSS and Graupner HoTT
- + Transmission of battery, receiver and GPS*/TAV* data
- + Virtually all features can be controlled from PowerBox and Jeti transmitters
- + Selectable servo frame rate: 12ms, 14ms, 16ms, 18ms
- + Servo feedback current suppression
- + High-performance machined heat-sink for optimized heat diffusion
- + Machined, anodized aluminium switch and screen case
- + Compact dimensions

*with **GPS III**

1. INITIAL INSTALLATION: GENERAL SEQUENCE OF OPERATIONS

When installing the unit, it is important to keep to the standard sequence described below, and adhere to the subsequent setup stages, as this ensures that your installation of the **PowerBox Mercury SR2** will be swift and problem-free. The individual points are explained in full in the remainder of these instructions:

- Mounting the PowerBox, switch and screen
- Connecting the receiver and batteries
- Settings in the Basics menu
- Setting up all the functions at the transmitter
- **Carrying out the Setup Assistant**
- Carrying out the Door Sequencer Assistant ⁴
- Assigning all remaining functions in Output Mapping
- Setting up all control surface travels, flight modes, Dual-Rate, Expo etc. at the transmitter
- Using Servo Matching to equalize servos operating in parallel
- Learning the stick end-points in the iGyro menu ⁵
- iGyro set-up flight ⁵
- Fine-tuning the iGyro ⁵

⁴ entfällt ohne Fahrwerkstüren

⁵ entfällt ohne Gyro

2. INSTALLATION, CONNECTIONS

a) Mounting

The **PowerBox Mercury SR2** should be mounted in the model on a robust sub-structure using the four screws, rubber grommets and brass eyelets supplied in the set. The installed location is not important, but if an **iGyro SAT** is to be used, the sensor must be installed perpendicular to the model's centreline. Ideally the TFT screen should be in a clearly visible location. The bright screen lighting makes it easy to read even in sunshine, so no special provisions have to be made here. The screen is connected to the socket marked **Display** on the side of the PowerBox.

The switch should be mounted in the fuselage side. As with previous units, a wooden doubler should be glued to the inside of the switch aperture - especially if the fuselage is made of GRP - in order to avoid subjecting the switch to powerful vibration. The set includes a template for the switch aperture. An exposed switch is

often undesirable in scale models, and for such applications we offer an alternative switch in the shape of the **MagSensor**. However, please note that the SensorSwitch is required for the programming procedure - unless you are using a PowerBox or Jeti RC radio system - and for this reason it should always be available for use. The SensorSwitch is plugged into the socket marked **Switch** on the side of the Power-Box.

b) Receivers

Once you have installed the **PowerBox Mercury SR2**, the screen and the switch, it is time to connect the receivers. In principle all SRS PowerBox systems are totally reliable when used with a single receiver. However, in view of the low cost of a second receiver compared with the value of the model, we always recommend installing a second receiver.

Ideally the receivers should be spaced well apart inside the model, as this increases the likelihood that at least one receiver will have good reception at all times - even under difficult reception conditions. It is permissible to extend the serial bus connection between receiver and backer to any length, as the signal is digital, and therefore extremely resistant to external influences.

The **PowerBox Mercury SR2** can be used with a wide range of radio control systems: PowerBox CORE P²BUS, Futaba S.BUS2, Jeti EX-BUS, Spektrum SRXL2, Multiplex M-Link, JR DMSS and Graupner Hott. The first four systems share one common feature: servo signals and telemetry data are carried on a bus system, and this allows the receivers to be connected to the Mercury SR2 using a single patch lead each. Multiplex and Hott systems require an additional connection between the **TELE**- output of the PowerBox and the receiver's telemetry input.

The **PowerBox Mercury SR2** automatically detects the system to which it is connected. However, when the radio is first switched on it may take a few seconds before the system is unambiguously recognised. Once detected, the unit stores the system type, and it will start immediately next time it is switched on.

• PowerBox ATOM/CORE

Connect one or two receivers to RX1 and RX2 at the **P²BUS** output. If only one receiver is to be used, it must be connected to RX1 to provide telemetry transmission. If a **GPS III** or a **PBS-TAV** is connected to the FastTrack input, the Mercury also delivers this flight data to the transmitter.

• **Jeti EX-BUS**

One output of the receivers you intend to use must be set to **EX-BUS**. The frame rate should be set to 10ms, and the Failsafe function must be OFF. If you intend to use only one receiver, then it must be connected to RX1 to transmit telemetry data. If a **GPS III** or a **PBS-TAV** is connected to the FastTrack input, the Mercury also delivers this flight data to the transmitter.

• **Futaba S.BUS2**

Connect one or two receivers to RX1 and RX2 at the **S.BUS2** output. If only one receiver is to be used, it must be connected to RX1 to provide telemetry transmission. This receiver must also be defined as the telemetry receiver at the transmitter. In order to receive telemetry data, you must carry out a **Load New** process in the Telemetry Sensor menu; this action completely erases the sensor list. Now select **Slot 16** in the sensor list, and select **PowerBox**. The telemetry data now appear in Slot 16 or later. If a **GPS III** or a **PBS-TAV** is connected to the FastTrack input, the Mercury also delivers this flight data to the transmitter.

Note: do not attempt to register the PowerBox as a sensor at the transmitter; this function is not implemented.

Note: do not attempt to register the PowerBox as a sensor at the transmitter; this function is not implemented.

• **Spektrum SRXL 2**

Connect one or two SPM4651T satellites to the **PowerBox Mercury SR2** using the optional adapter lead set (#9192). If only one receiver is to be used, it must be connected to RX1 to provide telemetry transmission. At the transmitter you will now see the battery data displayed under PowerBox Sensor. If a **GPS III** or a **PBS-TAV** is connected to the FastTrack input, the Mercury also delivers this flight data to the transmitter.

By default, the Mercury works in DX18 compatibility mode.

• **Multiplex M-Link**

Set the B/D sockets of the receivers you intend to use to **SRXL V2**. This gives you sixteen channels. The Failsafe function must be OFF.

To use telemetry, you must disable the Telemetry function of one receiver using Multiplex Launcher. The Tele output of the PowerBox should be connected to the Sensor input of the other receiver.

If a GPSIII or a PBS-TAV is connected to the FastTrack input, the Mercury also delivers this flight data to the transmitter.

- **Graupner Hott**

Set one output of both receivers to **SUMD-OF16**. For example, if the receiver is a GR16/24, this will be output 8. Connect these outputs to the RX1 and RX2 inputs of the PowerBox. If a **GPS III** or a **PBS-TAV** is connected to the FastTrack input, the Mercury also delivers this flight data to the transmitter.

For the telemetry function, you must connect the TELE output of the PowerBox to the Telemetry input of one receiver.

Note: Only one receiver (Bind A or Bind B) can transmit telemetry!

c) Connecting the batteries

It is possible to use 2S LiPo, 2S Lilon, 2S LiFePo or 5S NiMH batteries with the Mercury SR2. We recommend that you use our **PowerPaks**, which feature integral charge electronics. The fundamental rule regarding battery size is that one battery on its own should be capable of powering the model reliably.

If you intend to assemble your own batteries, please note that correct polarity is vitally important. The unit does not include reverse polarity protection, as this would involve performance losses.

Note: Connecting a battery to the PowerBox with incorrect polarity, even very briefly, will immediately destroy the voltage regulators!

3. SWITCHING ON AND OFF

This is the procedure for switching the **PowerBox** on: hold the SET button pressed in until the LED glows red. Continue to hold it pressed in while you also press buttons I and II briefly to confirm the switching process. This method enables you to switch the batteries on individually; for example, in order to check that both packs are working properly, and deliver sufficient current when all the control surfaces are moved.

The same procedure is used to switch off.

The OLED screen now displays the following image:

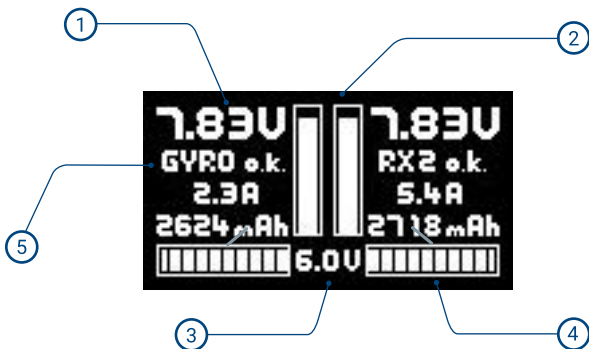

- 1 Analogue and digital battery voltage display. The scale of the analogue display is matched to the battery type you have selected. The supplementary digital display states the exact value.
- 2 Digital current display: shows the current which is drawn from each battery individually.
- 3 Display of the voltage which is actually available at the output.
- 4 The consumed capacity is displayed separately for both batteries. It can also be reset from the transmitter using a channel.
- 5 At this point the status of the receivers, gyro and GPS are displayed.

4. MAIN MENU

To access the menu you need to hold the SET button pressed in for about 2 - 3 seconds, after which you can select the desired menu using buttons I and II. Press the SET button once you have selected a menu point. You can now alter the values and settings using buttons I and II.



The “Rotary Menu” shown above contains the following sub-menus:

- **iGyro**

Here you will find all the settings relating to the iGyro. These features are only available if an iGyroSAT is connected to the unit.

- **ServoMatching**

If you have servos which are mechanically inter-connected, you can use this sub-menu to adjust them to match each other using a five-point curve. You will also find the Auto Matching function here.

- **Sequencer**

At this point you can set up the door sequencer, either manually or with the help of the Assistant.

- **Output Mapping**

In this menu you can assign all 16 outputs directly to any transmitter channel, to a Gyro output or the door sequencer.

- **Input Mapping**

The transmitter channels are assigned to the iGyro or sequencer here.

- **Basics**

This menu is used to alter fundamental settings such as the language or frame rate.

- **Assistent**

Always use the Setup Assistant when you are preparing a new model for its first flight. This is where the transmitter input channels are determined, the model type selected, and the servos assigned to the outputs. In just a few minutes the primary functions can be ready for use, and the Assistant procedure makes it much easier to set up the gyro functions at a later stage.

- **Reset/Update**

At this point you can reset individual ranges. The Update point activates the Data port for connection to a PC using the USB interface lead (#9020).

5. BASIC SETTINGS

Before you start using the primary functions (with the help of the Setup Assistant) and connect the servos, you should enter the basic settings in the **General Settings** menu.

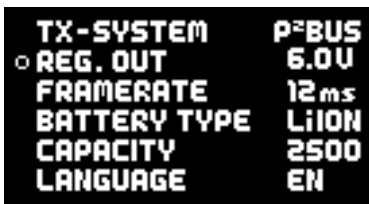

TX-SYSTEM	P²BUS
○ REG. OUT	6.0V
FRAMERATE	12ms
BATTERY TYPE	LiION
CAPACITY	2500
LANGUAGE	EN

- **Radio control system**

This menu point cannot be selected manually. As already mentioned, the unit automatically detects the radio control system. If you have already connected your receivers and bound them to the transmitter, you will see at this point the radio control system it has detected.

- **Regulator output**

Hier stellen Sie die Ausgangsspannung ein. Sie können zwischen 6.0V und 7,8V wählen.

Bei HV Servos empfehlen wir die 7,8V Option: Damit haben Ihre Servos nach dem Einschalten eine längere Zeit konstantes Drehmoment und Geschwindigkeit. Die kurzzeitig höhere Spannung der Akkus nach dem Laden wird auf ein Niveau herabgesetzt, welches der Akku länger halten kann.

- **Frame rate**

Diese steht standardmäßig auf 16ms. Damit funktionieren alle gängigen Servotypen zuverlässig. Digitalservos können eine bessere Performance erreichen, wenn Sie die Framerate auf 12ms stellen. Ältere Anlogservos dagegen können bei zu niedrig eingestellter Framerate heiß werden und finden die Stellposition nicht exakt.

- **Battery type**

At this point you should enter the battery type, to enable the unit to match the graphical display to the characteristics of the battery you are using.

- **Capacity**

The capacity counter can be operated in count-up or count-down mode:

- a) If you wish to display the consumed capacity, set 0mAh at this point. The capacity counter now counts up.
- b) If you wish to see a count-down display, enter the capacity of your battery at this point.

In both cases it is possible to access the Input Mapping menu and assign a channel which is used to reset the battery capacity. The default assigned setting here is channel 16.

- **Language**

Select German or English as menu language.

6. SETUP ASSISTANT

The Setup Assistant is designed to help you complete basic channel and servo assignments quickly and easily. We recommend that you continue to use the Setup

Assistant even if you are very familiar with the workings of PowerBox products. You should also use the Assistant even if you (temporarily) do not wish to use an **iGyro SAT**.

On the one hand the Assistant simplifies operations, because the menu initially refers to outputs in general terms, such as **DIRECT-xy**, but once you have completed the Assistant it uses specific designations, for example, **Right aileron** ... etc.

On the other hand, it is possible to retro-fit an **iGyro SAT** without having to re-program the battery backer. All assignments are already complete, and even the servo matching is maintained.

Note: When setting up the **PowerBox Mercury SR2** for the first time, please keep to this sequence:

Setup Assistant (basic setup) -> **Sequencer Assistant** -> manual output assignment of all other functions

Before you select the Setup Assistant, establish all the primary functions at the transmitter, ideally with 50% travel. Mixers such as delta, tailerons and thrust vector must also be programmed at the transmitter before you start. Check the functions using your transmitter's servo monitor. At this stage servo centre positions and directions of rotation do not matter.

If you also intend to use an **iGyro SAT**, you should now install the gyro sensor in a suitable position, perpendicular to the fuselage centreline, and connect it to the socket marked **FastTrack** on the **PowerBox Mercury SR2**. If you are also using a **GPS III** or **PBS-TAV** as telemetry sensor (and for gyro speed compensation), this should also be connected to the **FastTrack** input using a Y-lead.

Select the **Assistant** widget in the Main Menu, and you will see the following displays:

• WING TYPE	NORMAL
TAIL TYPE	TAILERON
VECTOR	NO
BACK	NEXT

FUNCTION	SERVOS
• AILERONS	4
ELEVATORS	2
RUDDER	2
BACK	NEXT

In the first display you select the wing type (Normal / Delta) and the tail type (Normal, Tailerons or V-tail). You can also determine whether the model has a thrust vector system.

On the next screen you enter the number of servos you wish to assign to individual control surfaces. The Assistant supports a maximum of three servos per control surface. This means: if your model is fitted with overall four aileron servos, enter 4 behind ailerons.

You will now see further screen displays which vary according to the data you have already entered. The following illustrations show the aileron channel as an example, based on the above data:



Now move the aileron stick at the transmitter: the PowerBox checks the input: in this example four channels should move. Two for the ailerons and two for the tailerons. The screen shows now which channels have been detected, and the outputs to which you should connect the servos. Bearing in mind that your individual transmitter's channel sequence may not be as shown above, you may need to move the transmitter stick briefly and repeatedly until the detected channels appear after the appropriate functions.

Note: If multiple servos are mechanically coupled to a single control surface, disconnect the linkage to servos 2 and / or 3, as the servos are not yet matched to each other, and you could stall them!

Repeat the procedure with the elevator and rudder functions. After this you will be asked to enter the Gain channel for the iGyro.

You need to assign a channel with +/-100% travel to a rotary control at the transmitter. Even if you have not connected an **iGyro SAT**, this action is recommended as it will make it easier to retro-fit the gyro.

If you have selected a thrust vector function, you will see a second query regarding the sensitivity of the thrust vector control system. This is the method the Assistant uses to set up the basis for a simple but effective method of adjusting gyro gain in flight.

Once you have assigned the Gain control, press **Continue** to confirm your choice. If no **iGyro SAT** is connected, this concludes the Setup Assistant.

If an **iGyro SAT** is connected, the next step is to establish the installed orientation of the **iGyro SAT**:



This is accomplished by moving the model in the directions shown in the graphic display: first move the tail of the model up and down two or three times. You will see that the elevators follow this movement every time - the direction of effect is not important at this stage.

At the end of the movement hold the model's **up** and wait until the elevators return to neutral (centre).

Now repeat the procedure with the rudder (yaw) axis: move the tail to left and right two or three times – then hold the tail to the **right** until the rudder returns to neutral.

Note: This procedure can be awkward to carry out with larger models. However, there is a simple trick which makes learning the installed position easier: don't fix the **iGyro SAT** in the model until after the learning process is complete. During the learning procedure you simply move the **iGyro SAT** in the appropriate direction, rather than the model itself!

The Assistant now continues to the process of establishing the directions of effect ("sense") and learning the transmitter control end-points. Before you carry out this procedure, it is essential to set the direction of effect and the end-points of the primary functions at the transmitter.

**HOLD THE AILERON
STICK RIGHT**

**AND PRESS THE
SET BUTTON**

Note: At any time, you can repeat the procedure in the Gyro menu for setting the direction of effect and the end-points. This is absolutely essential in any case if you adjust the travels or directions of effect of the primary functions while you are setting up the model.

In this menu the system learns the aileron, elevator and rudder sticks as you hold each stick in the direction shown on the screen, and press the SET- button.

The Setup Assistant is now finished, but you can still assign additional outputs manually, carry out the Door Sequencer Assistant, or match multiple servos.

Note: In contrast to earlier versions of the PowerBox Assistant, it is now possible to repeat the Setup Assistant at any time. The system retains previously entered settings, and only overwrites the entries you have changed.

7. SERVO MATCHING

The Servo Matching function can be used to adjust all 16 outputs in travel and direction using five points. Its purpose is to match the travels of multiple servos which are mechanically interconnected, or which control multiple functions using only a single channel. For example, the rudder may be coupled to a steerable nosewheel.

Servo matching is divided up over three screen displays: in the first you select the output which is to be adjusted; in the second the output is initialised; in the third display the servo is adjusted.

In the initial Servo Matching screen you should select the output which you wish to adjust. At this point you can also reverse the output with a button-press, or move on to Auto-Matching.

OUTPUT A
INIT OUTPUT
START MATCHING
REVERSE OUTPUT
AUTO MATCHING

- **Initializing**

It is essential to carry out this step first.

First centre your transmitter stick, then select **Initialize**: now move the stick to both end-points. The screen displays the movement as a bar, and when the movement is complete, the small red markers remain in place at the end-points.

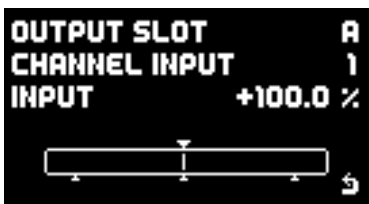

- **Reversing the output**

Um den Ausgang schnell umzupolen ohne jeden einzelnen Punkt einzustellen, wählen Sie einfach mit der SET-Taste **Ausgang umpolen** aus.

- **Start Matching**

Select this menu point if you want to adjust the travel of the selected servo manually using five points. The **PowerBox Mercury SR2** switches to this display:

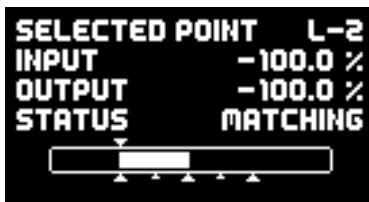

The method is very simple: move the transmitter stick to the approximate point which you wish to alter, then press the SET button. The servo now slowly moves automatically to this exact point.

Now you can alter the servo curve at this point using buttons I and II.

You don't need to use the transmitter to maintain the servo position; this makes accurate settings easier.

Once you have adjusted the curve point to the desired position, press the SET button again, and the servo slowly travels back to the position corresponding to the actual stick position.

If you now move the stick, you will see at **Input** the servo position corresponding to the transmitter stick position, and at **Output** the servo position now present at this servo.

Note: This action causes **all** the servos which are assigned to this input channel to move to the selected position. If this were not so, mechanically linked servos would immediately stall each other! *Servos sofort gegeneinander blockieren!*

• **Auto Matching**

The Auto matching function is a completely new development, and this is the first PowerBox product to include it. Its purpose is to match the travels of up to three mechanically interconnected servos accurately over five points, which it accomplishes in just a few seconds.

How does auto matching work?

The **PowerBox Mercury SR2** is fitted with the latest generation of micro-controller which is capable of measuring the current drawn from both batteries extremely quickly and precisely. The values for measured current are used to match two or three mechanically linked servos to each other.

This is accomplished by moving each servo to five points in turn and recording the lowest current values. The process is carried out in two steps: initially coarsely, then finely. A third stage then follows, in which fine-matching is carried out, taking into account any stiffness in the control surface hinges.

In the initial stage the servos are strained hard against each other for very brief periods (5 x 100ms). We have carried out hundreds of tests with this procedure, and have found that it presents no problems to servos - even low-cost examples. In fact, any linkage and servo must be capable of withstanding this procedure in any case, otherwise they would not be able to cope with flight loads.

Which servo types are suitable for auto matching?

All types of servos are suitable - with one exception: servos which do not become "soft" when the signal is switched off. There are a few digital servos which remain fixed at their position even when no signal is present. In steps 1 and 2 of auto matching this would cause the servos to draw a high current for an extended period, i.e., for as long as the matching process lasts, and this is not acceptable. Such servos can only be matched manually!

Start

In the first servo-matching display you select your **main servo** under **Output**. In most cases this would be - in the case of ailerons - the servo closest to the fuselage. Connect the servo, and set the centre and travel at the transmitter. **Initialize** the servo with maximum travels.

Now select **Auto Matching**. At this moment all the **PowerBox Mercury SR2's** other outputs are switched off, and you will see this screen:



```
SELECT MASTER  E
SELECT AUX 1   F
SELECT AUX 2   -
START MATCHING
CURRENT 2.37 A  ↗
```

Now connect the second and - if present - the third servo to the appropriate outputs, and complete the mechanical linkages. Now set for AUX1 and AUX2 the other participating outputs. When selected, these outputs are assigned to the same input channel as the **main servo**, and initialized. This means that you do not need to set the assignment of the participants beforehand in **Output Mapping**, and also do not need to initialize them.

For example, if you accidentally select the wrong output, and wish to cancel your choice, the output will be reset to its previous function.

Once you have completed the selection of the participants, move the cursor to **Start Matching**: the matching process commences. If you wish to interrupt the process, you can do this by pressing the SET button.

The procedure is automatically interrupted if the system fails to detect a minimum

current value; for example, if a linkage is overloaded at its end-point, or you forgot to install it.

A matching process for three servos takes about 30 - 40 seconds. You can follow the current consumption directly on the screen. When the matching is finished, use the transmitter stick to run the servos to all five points. A quiet buzz from the servos in one or other position is normal. If the buzzing stops when you touch the control surface lightly with your finger, then this shows that the matching process has worked accurately.

Minor corrections can be carried out at any time under **Manual Matching**. It is a good idea to check the servo matching occasionally before and during the flying season, as servos and mechanical systems are always prone to slight drift in use!

8. DOOR SEQUENCER

The **PowerBox Mercury SR2** incorporates a fully programmable door sequencer. This feature enables you to control the entire process for retracting and extending the undercarriage and wheel doors using a single channel at the transmitter.



The Sequencer menu is divided into three parts: selection of the function, the actual set-up screen for manual set-up using the graphic display, and the Setup Assistant. The illustration above shows the start of the Sequencer once you have initiated the Assistant. This is clear because the name of the function is shown as DOOR-FL rather than DOOR-A. The Assistant actually assigns names to the doors according to your entered data, making subsequent adjustments easier. More on this later.

Regarding the individual menu points:

- **Switch position**

Here the screen shows directly the current position of the assigned channel. If this position does not coincide with your preferred transmitter switch position, you can correct it at the transmitter using servo reverse.

- **Switched channel**

At this point you should define which transmitter channel is to be used to switch the sequencer. This setting is also present in **Input Mapping**. At the transmitter the switched channel travel should be set to -100% to +100%.

It is important to know that the door sequencer also includes a pause function: if you use a three-position switch and set it to 0%, the sequence stops at the current position. From this point you can continue or reverse the sequence according to the next switch position.

- **GEAR UP OUTPUT OFF**

At this point you can enter an output which is required to remain at a pre-defined position when the undercarriage is retracted. For example, this is important if the model is fitted with a steerable nosewheel, as it ensures that the wheel stays 'straight ahead' when the noseleg is retracted.

The position of this output is stored when you leave this menu point.

Caution! If you were to set the wrong output at this point - for example, the elevator channel - then the elevator channel would be switched off when you retract the undercarriage! The results of this are obvious, so please take particular care when setting up this point.

- **Function**

Here you select the function which is to be adjusted. The sequencer provides facilities for four individually variable functions. For example, an undercarriage with three wheel doors (individually controlled) needs four functions: three doors + retracts (valve or electronic unit).

Up to four travel points can be set up for each function. Each travel point is defined with a servo position and a time (delay) after the start point.

- **Manual Setup**

This menu enables you to set up and adjust the individual functions, and also fine-tune the timing and position of functions which the Assistant has already set up for you.

• Setup Assistant

As already described, the Setup Assistant prepares all the functions in the model in accordance with your requirements. The system learns all the door positions and the retract control system. After this, the Assistant assembles these positions in accordance with your selected mode (1-2-3 - see next page) in a timed sequence.

We recommend that you always use the Setup Assistant – it will save you a great deal of adjustment work, and any non-standard movements can subsequently be added at any time using **Manual Setup**.

a) Setup Assistant

The Setup Assistant is specifically designed to cater for retractable undercarriage sequences.



Once the Setup Assistant is selected, it has to learn a number of fundamental aspects:

• Mode

Three modes are available, representing different sequences.

- Mode 1:

Extension: all wheel doors open – undercarriage extends

Retraction: undercarriage retracts – all wheel doors close

- Mode 2:

Extension: all wheel doors open – undercarriage extends – rear wheel doors close

Retraction: rear wheel doors open – undercarriage retracts – all wheel doors close

- Mode 3:

Extension: all wheel doors open – undercarriage extends – all wheel doors close

Retraction: all wheel doors open – undercarriage retracts – all wheel doors close

• **Number of wheel doors**

Enter the number of doors. If all the wheel doors are to be operated by a single valve, enter a **1** at **Number of front doors**, and leave the **Number of rear doors** vacant.

• **Pause between undercarriage and doors**

Extend: The time the system waits after extending the undercarriage before the wheel doors close. Applies to u modes 2 and 3 only.

Retract: The time the system waits after retracting the undercarriage before the wheel doors close. Applies to all modes.

Note: All settings in the Assistant are stored – including all subsequent servo positions. For example, if you wish to change the retract mode or the pause period after completing the Assistant, simply run through the Assistant again without changing the positions. The Assistant then simply adjusts the timed sequence.

Once you have completed all these settings, select **NEXT**.



**CONNECT FRONT
DOOR TO OUTPUT J
POSITION DOOR CLOSED
+100%
BACK NEXT**

The positions of the undercarriage control system and all the wheel doors are now set up in accordance with the number of wheel doors you have entered. At this point you should connect the retract control unit and the wheel doors to the appropriate output of the **PowerBox Mercury SR2**. Starting with **A** the Assistant searches for outputs which have no special functions – i.e. **Direct xy** outputs, which are not assigned to a gyro or other sequencer function.

Note: It is important to keep to the standard sequence when installing the **PowerBox Mercury SR2** for the first time:

Setup Assistant (Basic setup) → **Sequencer Assistant** → manual output assignment of all other functions.

If you ignore this, the Sequencer Assistant could overwrite **Direct** functions which are already assigned.

When the positions are being established you will see that the wheel doors and the undercarriage itself always follow the cursor position, and slowly approach the set position. If you wish to adjust these positions, press the SET button and make changes using buttons I and II. Select **Finished** to adjust the other wheel doors. Once all the doors are correctly adjusted, the following display appears, and you may be asked to move the retract switch to **Extended**:



The Assistant now opens all the wheel doors and moves the undercarriage to the **Extended** position. At this point you can check the operation of the sequencer by operating the retract switch on the transmitter. If you find a problem - perhaps the pause between the undercarriage and the wheel doors is too short - you just select the Assistant again, and change the appropriate setting. There is no need to re-adjust the wheel door positions.

Should you wish to set up additional wheel doors or travel points, you can do this at any time in **Manual Setup**.

b) Manual Setup

You will find an overall view of the sequence for the selected function in the main Sequencer menu.

The upper line shows the sequence in the forward direction (extension), the lower line the reverse sequence (retraction).



In **Manual Setup** you can set four travel points in time and position for each function; forward and reverse processes are individually variable.

The current position and time are shown in the bottom line of the screen. Use buttons I and II to select the point you wish to change. The position of the servo follows the position of the cursor on the line. For example, if you select a point which stands at +80%, the corresponding servo moves slowly to the +80% position.

Note: When adjusting the wheel doors you should start by retracting and disabling the undercarriage itself, otherwise there is a risk of the doors fouling the wheel legs and causing mechanical damage.

To adjust a point, select the appropriate point using buttons I or II, and press the SET button; you can now adjust its position. Once the position is correct, you can set the time after pressing the SET button again.

All four points are permanent. If you want a particular point to produce no servo movement, set its position to the same value as that of the previous point. As a basic rule the time can only be entered between the two points at left and right. If you want to shorten the entire sequence, you must move all the points.

9. OUTPUT MAPPING

Output Mapping enables you to assign servo sockets to the transmitter channels and the gyro and sequencer functions.

All 16 outputs can be assigned, and there are no restrictions. For example, output A can be direct channel 5 from the transmitter, or a door sequencer function. It is also possible to assign one function to multiple outputs. For example, two elevator servos can be controlled from just one transmitter channel. Servo matching can then be used to match the control surfaces accurately to each other. This facility saves channels at the transmitter, where they can be in short supply.

Output Mapping is also used to set the Failsafe response of each individual channel.

In the **Output Mapping** display, you use buttons I and II to select the output you wish to assign:



Press the SET button to select the output.

- **Function type**

Three different function types are available:

- **Direct**

Selecting a **Direct** channel assigns a transmitter channel directly to the selected output without modification (except for servo matching). For example, if you assign Direct 5 to output K, then output K responds to channel 5 at your transmitter.

- **Gyro Ausgänge**

Once the Setup Assistant is complete, you can assign the gyro channels to the outputs. At the Select stage you will find, for example, **Aileron**, **Elevator** and **Rud-**

der functions. These functions can also be assigned to the outputs more than once. For instance, if you are setting up a model with three aileron servos in each wing, then you will find three instances of **Right aileron** and **Left aileron**. Gyro channels not assigned through the Setup Assistant are designated Ai-le-ABC, Elev-ABC and Rudd-ABC.

- Sequencer

This function type contains four outputs for each of the door sequencer functions. As in the case of the gyro, the sequencer outputs have general designations if the Assistant has not yet been completed - for example, Sequ-1. Once the Sequencer Assistant has been used, they are assigned specific names such as Door F (front) or Door RR (rear right).

• Function

At the Function point you can use buttons I and II to choose the function you wish to assign to the output. Various options are available here, depending on the function type you have selected.

• Hold/Fail:

This is where you set the Failsafe response for the selected output. By default, all outputs are set to **Hold** mode. However, it is really essential to set Failsafe (**FS**) on throttle, so that the power system is throttled back or cut completely should the signal be lost. In many countries this is a legal requirement in any case.

If you set an output to Failsafe, all current positions are adopted from the transmitter when you leave the menu point. This means: you should move all channels to the desired position at the transmitter before you set an output to Failsafe.

The usual way to check the setting is to move the throttle channel to the half-way point, then switch the transmitter off: the throttle servo must now immediately move to the Idle position.

If you are using a PowerBox radio system, the Failsafe settings are adopted from the transmitter; this overwrites any Failsafe settings which you select at the **PowerBox Mercury SR2**.

10. INPUT MAPPING

The Input Mapping menu is used to assign the channels coming from the transmitter to functions such as Gyro, Sequencer or capacity reset.

The assignment process is carried out by the Setup Assistant and the Sequencer Assistant. If you add functions later, or change channels at the transmitter, it is possible to make appropriate adjustments subsequently at any time.

In particular, assigning different Gain channels for the iGyro makes it easier to enter the settings for more complex applications.

○ GY AILERON A	1
GAIN AILERON A	14
GY AILERON B	5
GAIN AILERON B	14
GY AILERON C	-
GAIN AILERON C	-

○ SEQUENCER	12
CH. CAP. RESET	16

These pictures also clearly show the separate Gain channels for each gyro function. For example, aileron, elevator and rudder can be assigned three different Gain channels, which can then be adjusted individually in a single test-flight.

To assign a channel, use buttons I and II to select the function, then press the SET button. You now have two options for choosing the channel:

- Use buttons I and II
- Simply move the transmitter stick: the channel is automatically detected. If more than one channel is assigned to a particular transmitter control (for example, channels 2 and 6 for aileron control), repeatedly move the stick briefly from centre until the desired channel is selected.

Press the SET button to confirm your choice.

11. iGYRO

The iGyro menu provides access to a whole range of Expert settings which enable you to fine-tune the iGyro to meet your specific requirements.

The iGyro menu requires an **iGyro SAT** connected to the **FastTrack** input of the **PowerBox Mercury SR2** as sensor unit. An optional **GPS III** or **PBS-TAV** also connected to FastTrack - can be used to provide speed compensation for gyro gain.

It is important to carry out the Setup Assistant before you make any changes to the iGyro settings, as all the channel assignments will then be correct. A single test-flight with the base values then forms a good starting point for further fine-tuning.

○ AXIS	AILERON-A
RANGE	A
GAIN	75%
ATTITUDE ASS.	ON
CHARACTER.	HARD

○ STICK PRIORIT.	100 %
LOCKFEEL	20 %
AIRSPPEED FACT.	4
TEACH MOUNT. POS.	
TEACH STICKS	

• Gyro Axys

At this point you select the gyro axis which you want to adjust. Four axes are available for each of aileron / elevator and rudder.

• Range

Two ranges are available, each of which can be adjusted separately for each axis: range A and range B. Range A applies to values of the gain control (or gain switch, once set up) between 0% and +100%, while range B runs from 0% to -100%. At 0% the iGyro is completely disabled.

This enables you to set up two ranges: one range with Attitude Assist and a second without Attitude Assist. You can select either range in flight by means of a switch.

• Attitude Assist

We selected the term Attitude Assist because the iGyro's "Heading" actually differs substantially from the Hold modes used by other gyro manufacturers. Attitude Assist can also be used on the elevator without any problem, as it is only active at the stick's centre point, and there is no risk of causing a stall. As soon as the

stick is moved, Attitude Assist is disabled, and the model 'feels' perfectly normal. Once the Setup Assistant has been completed, Attitude Assist is active on aileron in range B by default.

- **Characteristic**

Changing this value hardens and softens the regulatory behaviour of the iGyro. If the model appears to respond too abruptly in gusty conditions, you should change the value in the direction of Soft. If you think that the iGyro responds too slowly to gusts of wind, change it in the direction of Ultra.

- **Stick Priority**

The default value for this menu point is 100%, which means that the gyro function is completely suppressed when the stick is moved to its end-point. If you set stick priority to 200%, for example, the gyro function will be completely suppressed when the stick is at half-travel. The result is a more agile model, but at the cost of a faster reduction in gyro effect as the stick movement is increased.

- **Lock feel**

This feature affects the model's ability to 'lock' in manoeuvres such as four-point rolls. If the value is set too high, the result is a tendency to overshoot or oscillate at the moment the stick is released. If the value is too low, the locking may not appear sufficiently sharp.

- **Airspeed Factor**

This value defines the effect of speed-dependent variation in gyro gain. The setting only applies if a **GPS III** or **PBS-TAV** is connected to FastTrack as well as an **iGyro SAT**. The airspeed factor should be increased if the model displays good gyro response at low to medium speed, but tends to oscillate at high speeds. Over the years the default value of 4 has proved ideal for all kinds of model.

- **Learning the installed orientation**

In this menu the unit learns the installed orientation of the **iGyro SAT**. In most cases this has already been established in the **Setup Assistant**, but if you change the location or the orientation of the **iGyro SAT**, you will need to use this menu point again.



The orientation of the gyro is established by moving the model in the directions shown on the screen: to ensure that detection is absolutely reliable, move the tail of the model smoothly up and down several times before holding the tail up until the elevators return to neutral. The direction of effect is not important at this stage.

Repeat the procedure with movement of the rudder: move it left and right repeatedly, then hold it in the "right" position.

Note: With larger models this procedure can be awkward to carry out. However, there is a simple trick which makes establishing the installed position easier: don't fix the iGyroSAT in the model until after the learning process is complete. During the learning procedure you simply move the iGyroSAT in the appropriate direction, rather than the model itself!

- **Learning the transmitter stick end-points**

This setting is very important, and should always be carried out if you alter the centre or end-points of the aileron, elevator or rudder gyro functions.



Follow the instructions on the screen to learn the stick end-points. Please note that you must select the stick you wish to learn, and hold it at its end-point while you press the SET button.

12. GYRO SETTINGS – BEFORE THE FIRST FLIGHT

It is absolutely essential to carry out Point 12 if you have installed an **iGyro SAT**. You must also complete the following points before you start fine-tuning the iGyro in flight:

- + Settings in the General Settings menu
- + Setup Assistant completed – installed orientation learned
- + Door sequencer set up if appropriate
- + All other functions assigned, including throttle, flaps etc.
- + All functions set up correctly: servo centre, end-points, servo matching, Dual
- + Rates and Expo

The next step is to enter the iGyro menu with the cursor right at the bottom, so that the menu jumps to the second page. There you will find the **Learn transmitter stick end-points** menu point. Carry out this step as described above, in order to calibrate all the settings which have been entered in the course of the installation procedure.

Once you have completed these steps, turn the gyro gain control (or controls, if your model has a vector control system) to maximum, and check the direction of effect of the gyro. The intelligent iGyro learning process effectively prevents the need for corrections here - unless you have made an error when learning the sticks or the installed orientation. If this should happen, simply repeat the appropriate point in the iGyro menu.

It is important to know that the gain control has two ranges, as explained above: range A and range B. In range B the Assistant assigns Attitude Assist to the aileron function. We recommend this setting on the ailerons, as it results in very precise gyro response. During the test-flight we suggest that you turn the gain control to the left (0% to -100%) in order to make use of this feature immediately. Later on, you can fine-tune ranges A and B individually at any time.

Your model is now ready to fly. Set the gyro gain control to 0%, and take the model off. On this first flight it should be trimmed out carefully without using the gyro function.

Should you need to adjust the trims, or correct the control surface travels, during or after that first flight, it is essential to re-learn the stick end-points in the Gyro menu.

The iGyro is now ready for the model's initial set-up flight. Take the aircraft off with gyro gain set to 0%. Hold the model straight and level while you (or a colleague) slowly turn the gain control to the left - or right, if you do not want to use Attitude Assist on the ailerons.

Slowly turn the gain control until the model begins to oscillate. Once you have found this point, turn the gain control back slightly. Now fly a few circuits with this setting. Fly loops, rolls, knife-edge passes, and the model should exhibit no tendency to oscillate at any time.

As soon as you have found this optimum setting, bring the model in for a landing. Switch to your transmitter's servo monitor, and read off the percentage value for gain. You can now swap the rotary control for a switch, and enter the associated servo travel as the percentage you have just established. A value of 0% disables the gyro.

If your model features thrust vector control, the Setup Assistant has already assigned a second gain control. This is used to set the optimum gyro response for the vector function in a separate test-flight. Gyro gain for thrust vector control generally requires a value higher than 100%. Since the **PowerBox Mercury SR2** features integral gain controls for each individual gyro function, it is possible to implement different flight modes at the transmitter with no great effort.

13. TECHNICAL DATA

Operating voltage	4,0 V - 9,0 V
Power supply	2s LiPo, 2s Lilon, 2s LiFePo, 5s NiMH
Current drain, operating	100 mA
Current drain, stand-by	30 µA
Maximum current capacity	2 x 20 A continuous (<30 s: 2 x 40 A
Drop-out voltage	0,3 V
Output voltage	6,0V or 7,8V
Signal input	Serial
RC systems supported	PowerBox, Futaba, Jeti, Spektrum, M-Link, JR und Hott
Receiver redundancy	SRS
Channels	26
Servo outputs, total	16
Servo signal resolution	0,5 µs
Signal repeat rate	12 ms, 14 ms, 16 ms, 18 ms
Gyro modes	Heading mode, Normal mode
Gyro sensor type	External iGyro SAT
Number of sensor axes	9
Telemetry systems supported	P ² BUS, S.BUS2, EX-Tele, SRXL2, M-Link, DMSS, Hott
Dimensions	89 x 54 x 19 mm
Weight	75 g
Weight, Sensor-Switch	15 g
Temperature range	-30 °C – +75 °C

14. SET CONTENTS

- **PowerBox Mercury SR2**
- **OLED-Display M**
- **SensorSwitch**
- 2 patch-leads
- 8 retaining screws
- 4 rubber grommets and brass sleeves
- Operating instructions

15. DIMENSIONS

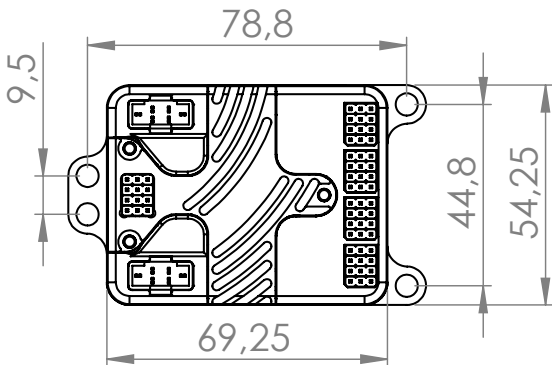

16. SERVICE NOTE

We make every effort to provide a good service to our customers, and have now established a **Support Forum** which covers all queries relating to our products. This helps us considerably, as we no longer have to answer frequently asked questions again and again. At the same time it gives you the opportunity to obtain assistance all round the clock, and even at weekends. The answers come from the **PowerBox team**, which guarantees that the answers are correct.

Please use the Support Forum **before** you contact us by telephone.

You will find the forum at the following address:

www.forum.powerbox-systems.com



17. GUARANTEE CONDITIONS

At **PowerBox-Systems** we insist on the highest possible quality standards in the development and manufacture of our products.

They are guaranteed **"Made in Germany"**!

That is why we are able to grant a **24 month guarantee** on our **PowerBox Mercury SR2** from the initial date of purchase. The guarantee covers proven material faults, which will be corrected by us at no charge to you. As a precautionary measure, we are obliged to point out that we reserve the right to replace the unit if we deem the repair to be economically unviable. Repairs which our Service department carries out for you do not extend the original guarantee period.

The guarantee does not cover damage caused by incorrect usage, e.g. reverse polarity, excessive vibration, excessive voltage, damp, fuel, and short-circuits. The same applies to defects due to severe wear.

We accept no liability for transit damage or loss of your shipment. If you wish to make a claim under guarantee, please send the device to the following address, together with proof of purchase and a description of the defect:

SERVICE ADDRESS

PowerBox-Systems GmbH
Ludwig-Auer-Straße 5
86609 Donauwoerth
Germany

18. LIABILITY EXCLUSION

We are not in a position to ensure that you observe our instructions regarding installation of the **PowerBox Mercury SR2**, fulfil the recommended conditions when using the unit, or maintain the entire radio control system competently.

For this reason we deny liability for loss, damage or costs which arise due to the use or operation of the **PowerBox Mercury SR2**, or which are connected with such use in any way. Regardless of the legal arguments employed, our obligation to pay damages is limited to the invoice total of our products which were involved in the event, insofar as this is deemed legally permissible.

We wish you every success using your new **PowerBox Mercury SR2**!



Donauwoerth, October 2022

PowerBox-Systems GmbH

Ludwig-Auer-Straße 5
86609 Donauwoerth
Germany

 +49-906-99 99 9-200

 sales@powerbox-systems.com

www.powerbox-systems.com